

ECOFLOW POWEROCEAN (SINGLE-PHASE)

Home Solar Battery Solution

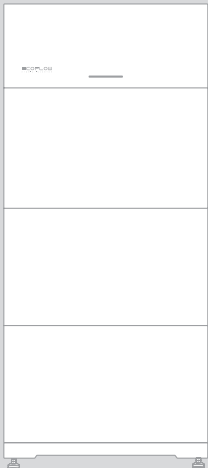

For the latest documents, please scan the QR code or visit:

Q <https://enterprise.ecoflow.com/eu/documentation>

IMPORTANT

- Before installing, operating, and maintaining the equipment, read and follow up Installation Guide and Safety Instructions.

CHANGE HISTORY

Changes between document issues are cumulative. The latest document issue contains all the changes made in earlier issues.

Issue 1.4 (2025-01-14)

- Deleted **N and PE cables are connected together in the Main Panel for wiring.**

Issue 1.3 (2024-09-12)

- Added **EcoFlow PowerOcean System Cascading.**
- Added **Integrating Existing PV System to the EcoFlow PowerOcean System.**

Issue 1.2 (2024-06-05)

- Added EcoFlow smart meter (for UK deliverables) to section **What's In The Box.**

Issue 1.1 (2024-05-29)

- Replaced the **METER communication terminal of the equipment.**
- Updated **Connecting Smart Meter.**
- Added **CT Installation Direction.**
- Added **Wall Mounted Instruction.**





Issue 1.0 (2024-03-07)

- This issue is the first official release.

CONTENTS

1	Safety Instructions
2	Preparing Tools and Instruments
3	What's In The Box
4	System Installation
4	Installation Environment Requirements
4	Installation Space Requirements
5	Installing Battery
8	Installing Inverter
9	Electrical Connection
9	EcoFlow PowerOcean System
10	(Optional) Integrating Existing PV System to the EcoFlow PowerOcean System
11	(Optional) EcoFlow PowerOcean System Cascading
12	EcoFlow PowerOcean System Wiring Diagram
12	(Optional) EcoFlow PowerOcean Cascading Wiring Diagram
14	Connecting PE Cables
14	Connecting GRID Cables
15	Connecting BACKUP Cables
16	Installing COM Connector With Shorting Wire
17	(Optional) Installing Emergency Stop (EPO)
18	(Optional) Connecting Communication Cables between the cascaded EF HD-P1-(3K-6K)-S1
19	Connecting PV Input Cables
21	Connecting Smart Meter
25	(Optional) Connecting Three-Phase Smart Meter to PowerOcean and Third-Party Inverter
26	Connecting to Internet
27	Installing trim cover
27	Installing EcoFlow IOT Dongle ESS
27	(Optional) Installing EcoFlow 4G Dongle ESS(EU)
28	System Commissioning
28	Checking before Power-On
28	System Power-On
28	System Power-Off
28	LED Indicators
29	System Commissioning
33	How Users Add Devices
34	(Optional) Inverter Cascading

Safety Instructions





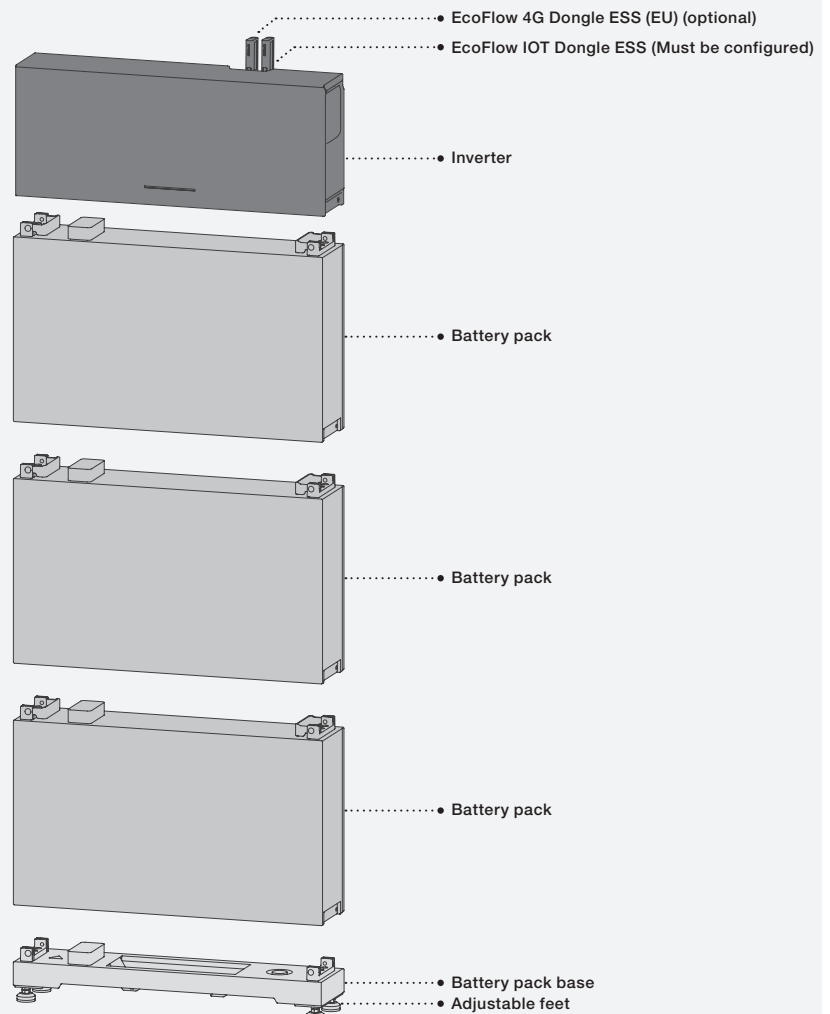





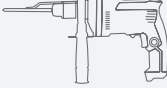
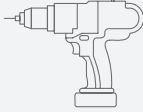
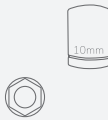

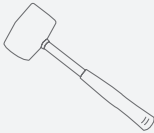
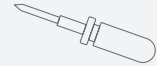
Symbol	Description
 DANGER	Indicates a hazard with a high level of risk which, if not avoided, will result in death or serious injury.
 CAUTION	Caution, risk of electric shock.
 WARNING	Indicates a hazard with a medium level of risk which, if not avoided, could result in death or serious injury.
 CAUTION	Indicates a hazard with a low level of risk which, if not avoided, could result in minor or moderate injury.
 NOTICE	Indicates a potentially hazardous situation which, if not avoided, could result in equipment damage, data loss, performance deterioration, or unanticipated results. NOTICE is used to address practices not related to personal injury.

-  **DANGER**
 - Before installing, operating, and maintaining the equipment, read and follow up Installation Guide and Safety Instructions.
 - Personnel who plan to install or maintain EcoFlow equipment must receive thorough training, understand all necessary safety precautions, and be able to correctly perform all operations.
 - Personnel who will install, operate, and maintain the equipment, including operators, trained personnel, and professionals, should possess the local national required qualifications in special operations such as high-voltage operations, working at heights, and operations of special equipment.
 - Before connecting cables, ensure that the equipment is intact. Otherwise, electric shocks or fire may occur.
 - Before installing, operating, and maintaining the equipment, **always disconnect it from all power.**
 - Wear proper PPE (Personal protective equipment) before any operations.

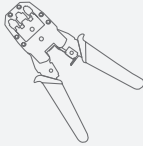

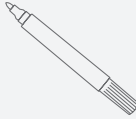
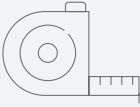

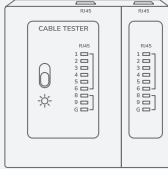

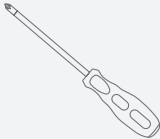
Preparing Tools and Instruments

• ESSENTIAL TOOLS

					
Hammer drill (with a drill bit of 8mm)	Electrical Screwdriver	Torque socket of 10mm	Multimeter (DC voltage measurement range ≥ 1000 V DC)	Mallet	Screwdriver ⊖ (SL3) ⊕ (PH3) ⊙
					
Cable cutter	Crimping tool	Wire strippers	RJ45 Crimping tool	Crimping tool (for tubular terminal)	Wrench (14mm)
					
Marker	Steel measuring tape	Cable tie	Network cable tester	Heat gun	Heat-shrink tubing
					
Screwdriver (PH2)					

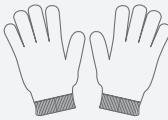
• OPTIONAL TOOLS











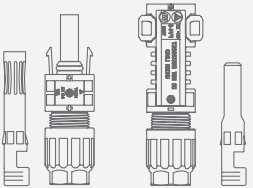
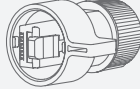

				
Vacuum cleaner	Safety goggles	Safety shoes	Safety gloves	Dust mask

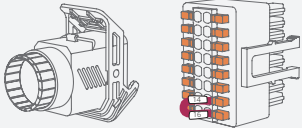
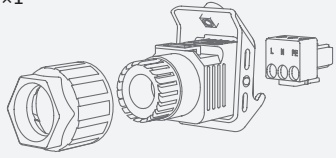
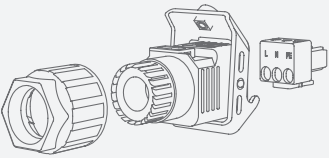
What's In The Box

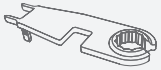

NOTICE

- Check if the deliverables are intact and complete. If any item is missing or damaged, contact the supplier.
- Retain the original packaging and documentation for further needs.

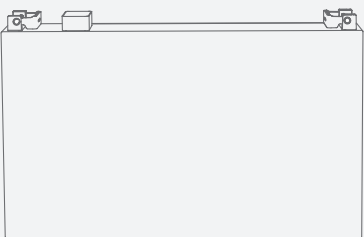
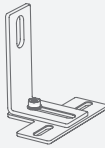

• ECOFLOW POWEROCEAN HYBRID INVERTER

<p>A1 ×1</p>  <p>EcoFlow PowerOcean Hybrid Inverter</p>	<p>A2 ×1</p>  <p>EcoFlow IOT Dongle ESS</p>	<p>A3 ×2</p>  <p>PV terminals</p>		
<p>A4 ×1</p>  <p>WAN port connector (Ethernet)</p>	<p>A5 ×1</p>  <p>METER port connector (RS485)</p>	<p>A6 ×1</p>  <p>COM connector with shorting wire</p>		
<p>A7 ×1</p>  <p>Grid connector</p>	<p>A8 ×1</p>  <p>Backup connector</p>	<p>A9 ×5</p>  <p>Screws(M5*12)</p>	<p>A11 ×2</p>  <p>PV Disassembly and Assembly Tool</p>	
<p>A12 ×2</p>  <p>OT terminal</p>	<p>A13 ×7</p>  <p>Tubular Terminal (For wire gauge 10AWG/6mm²)</p>	<p>A14 ×5</p>  <p>Tubular Terminal (For wire gauge 18AWG/1mm²)</p>	<p>A15 ×3</p>  <p>Tubular Terminal (For wire gauge 26AWG/0.25mm²)</p>	<p>A16 ×1</p>  <p>EcoFlow smart meter (For UK deliverables only)</p>

• ECOFLOW POWEROCEAN LFP BATTERY

<p>B1 ×1</p>  <p>EcoFlow PowerOcean LFP Battery</p>	<p>B2 ×2</p>  <p>Battery T-shaped mounting piece(M6) Battery L-shaped mounting piece</p>	<p>B3 ×8</p>  <p>Screws(M5*12)</p>	<p>A10 ×2</p>  <p>Expansion bolt(M6*60)</p>
--	--	--	---

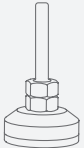
• ECOFLOW POWEROCEAN LFP BATTERY BASE

<p>C1 ×1</p>  <p>Battery base</p>	<p>C2 ×4</p>  <p>Adjustable feet</p>	<p>C3 ×2</p>  <p>Expansion bolt(M6*60)</p>	<p>C4 ×1</p>  <p>Marking-off template for battery</p>
--	--	--	--

System Installation

Installation Environment Requirements



WARNING

- The installation and use environment must meet relevant international, national, and local standards for lithium batteries, and are in accordance with the local laws and regulations.

NOTICE

- When installing the equipment in a garage, keep it away from the drive way.
- The mounting structure where the equipment is installed must be fire resistant. Do not install the equipment on flammable building materials.
- Ensure that the installation surface is solid enough to bear the weight of the equipment.

AVOID DIRECT SUNLIGHT, RAIN, OR SNOW

WELL-VENTILATED AREA ONLY

VERTICAL POSITION

AVOID UNEVEN GROUND

AVOID PIPES & CABLES & REINFORCING BAR

IP65

0%-100% RH

-20°C -50°C

ALTITUDE

≤3000 m

DISTANCE FROM THE SEA

>500 m

AWAY FROM

Solvent

Gasoline

Heat source

Moisture

Explosive material

Flammable material

Infrared radiation

AWAY FROM CHILD & WORKING & LIVING AREAS

NOT INTENDED FOR MOBILE SCENARIOS

NOT INTENDED FOR IMPORTANT DEVICES

Installation Space Requirements



WARNING

- Reserve enough clearance around equipments to ensure sufficient space for installation and heat dissipation.

NOTICE

- Ensure there is enough space on both sides of the battery to facilitate the locking operation of the screws on the side of the battery.
- When installing two sets of batteries (number of battery packs ≥ 4), ensure that the minimum clearance between the two sets of batteries is 400mm, while greater clearance is also permitted if it is required by the specific local electrical codes.
- When installing multiple inverters, install them in horizontal mode if sufficient space is available and install them in triangle mode if no sufficient space is available. Stacked installation is not allowed.

• ONE ECOFLOW POWEROCEAN SYSTEM

Dimensions and Weights:

- Top section: 21.5kg, 732 mm height, 680 mm width, 30-60 mm clearance from wall.
- Middle section: 55.5kg, 1129 mm height, 680 mm width, 5.1kWh capacity.
- Bottom section: 10.2kWh capacity, 1525 mm height, 680 mm width.
- Right section: 15.3kWh capacity, 183 mm depth, 1525 mm height.
- Clearance requirements: ≥ 300 mm on all sides.
- Bottom clearance: 65-85 mm.

• ECOFLOW POWEROCEAN SYSTEM CASCADING
 - HORIZONTAL INSTALLATION MODE (RECOMMENDED)

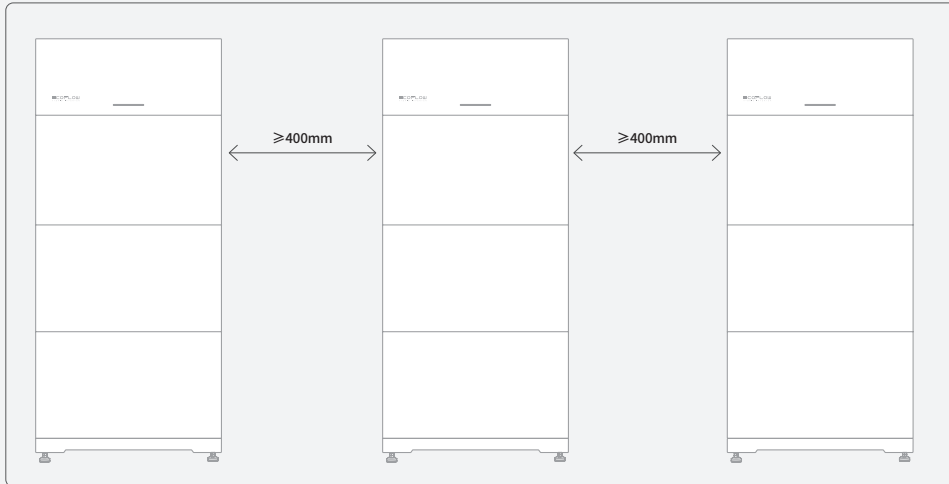

Installing Battery



DANGER

- When drilling holes, avoid the water pipes and power cables buried in the wall and under the floor.
- When drilling holes, protect the battery base from shavings or dust.
- Before installing the battery, make sure that the click-on terminals on the top and bottom of the battery are free of foreign objects or any liquid.



CAUTION

- Assign enough personnel (two or more) to move battery to avoid personal injury and battery damage.

NOTICE

- When moving battery, hold handles on top of the battery module.
- Sealant is applied underneath the battery base to ensure its resistance against water.
- There will be a gap between the battery junction box and the battery pack before the screws are tightened. This gap is caused by the mechanical design to meet the IP rating, and will normalize after the screws are tightened.
- **(Optional) Install the provided adjustable feet to the base if needed.** Then you can adjust the feet and check the level on the base to ensure that the base is placed horizontally, screw the nuts of the four feet to the top to lock.

Method 1: Floor Mounted

• WITH ADJUSTABLE FEET

1

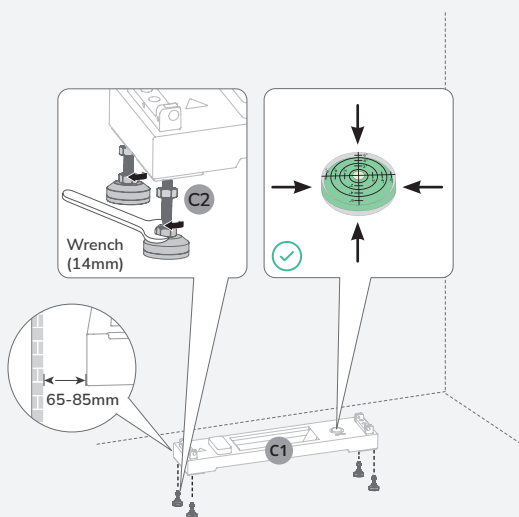

2

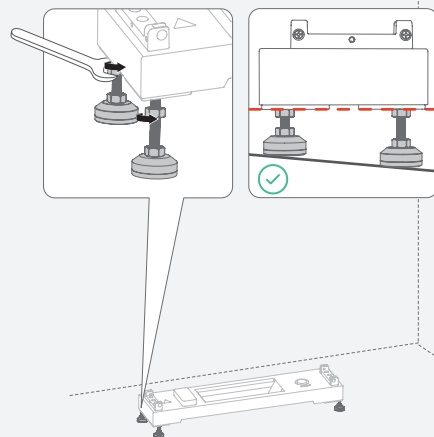

3

C4  x1

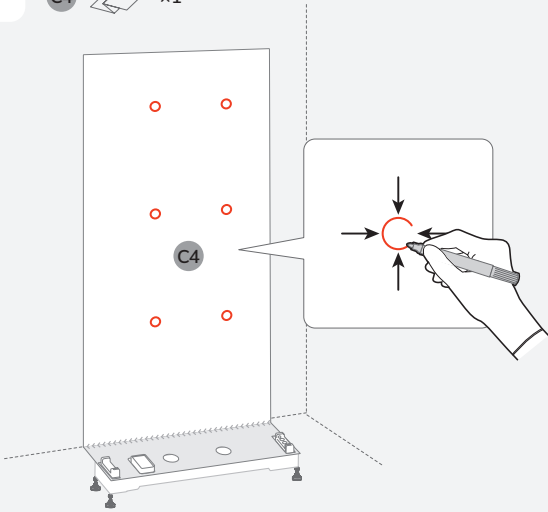

4

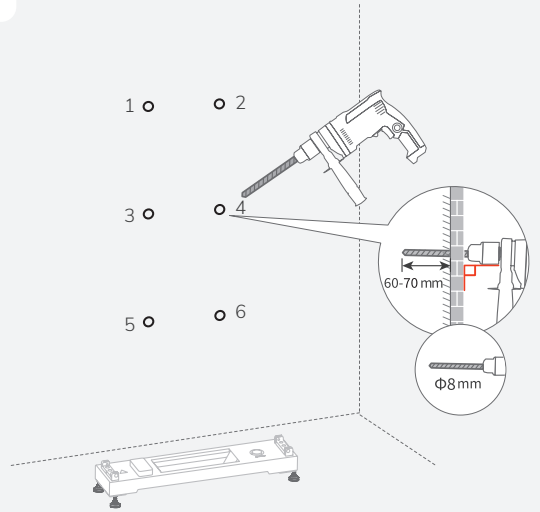

• WITHOUT ADJUSTABLE FEET

1

C1 

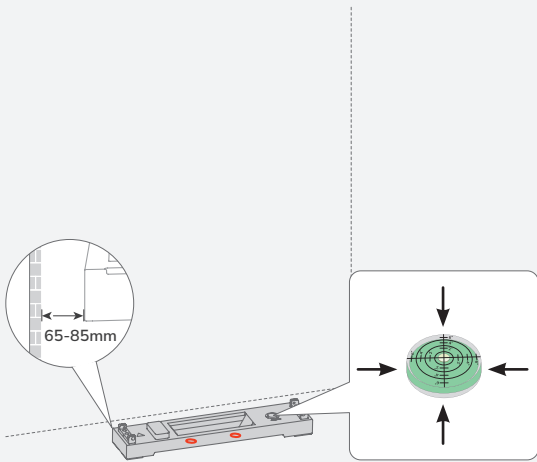

2

C4  x1

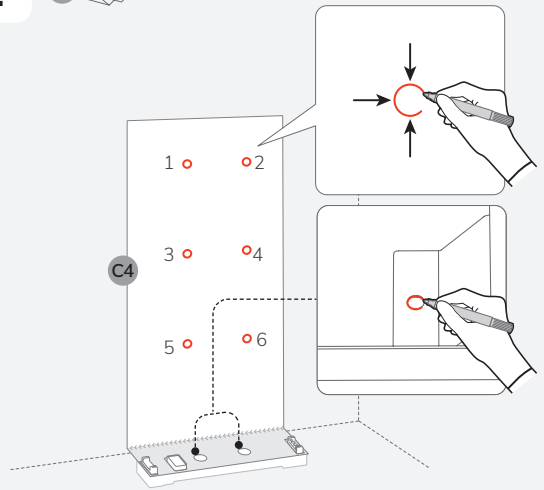

3

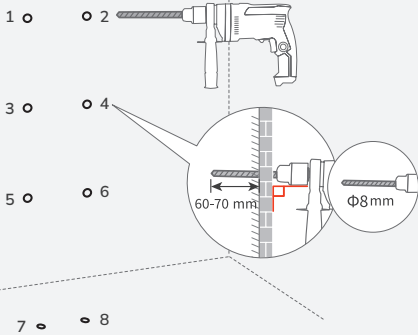

4

C3  x2

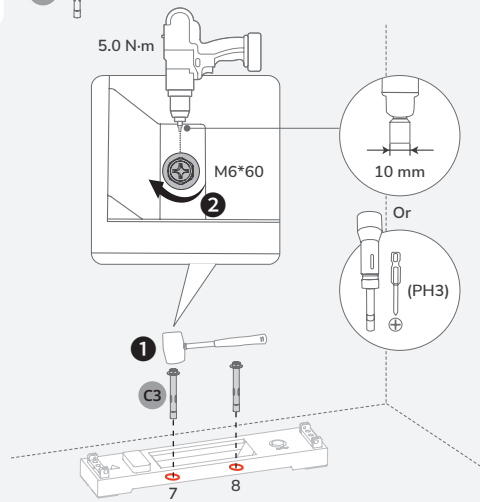

5 B1 x1 B2 x2 B3 x4

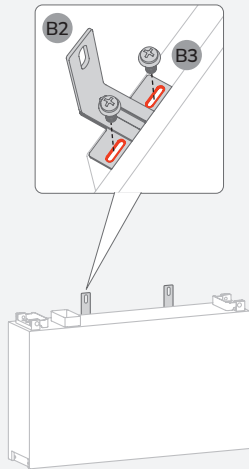

6 B3 x4

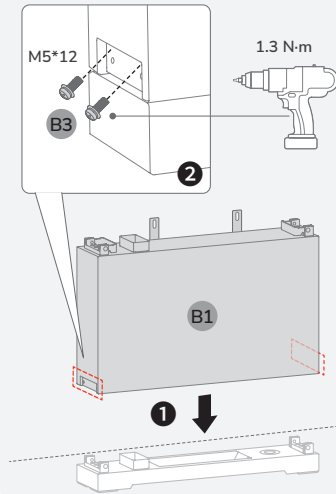

7 A10 x2

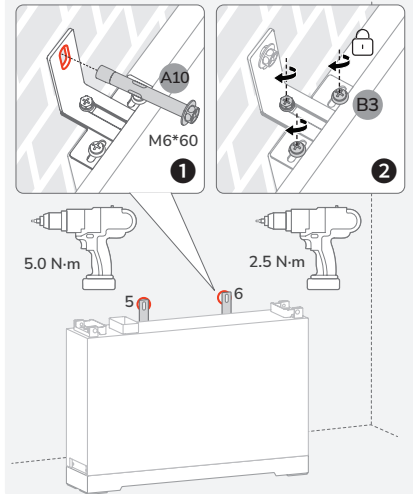

8 B1 x1 B2 x2 B3 x4 A10 x2

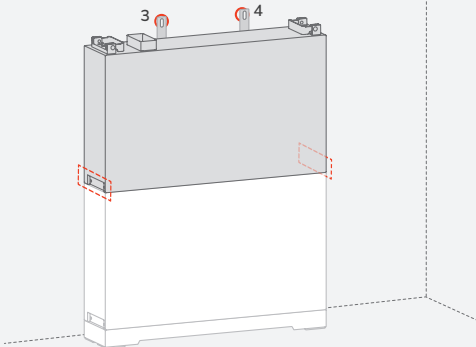

9 B1 x1 B2 x2 B3 x4 A10 x2

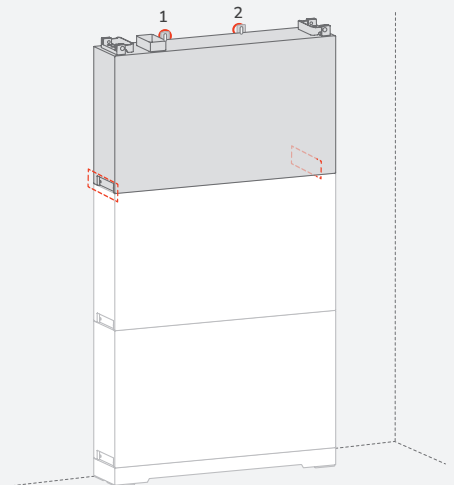

Installing Inverter

1

A1 x1

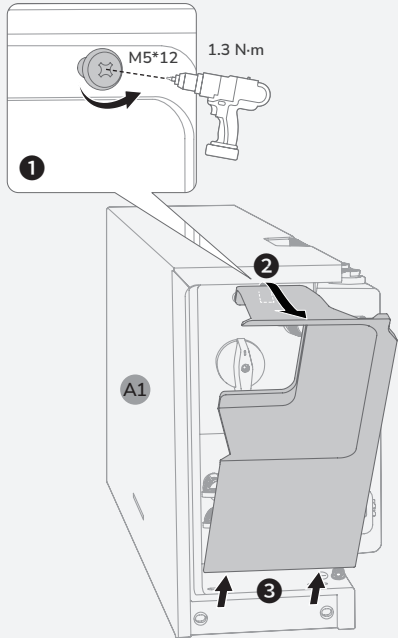

2

A9 x4

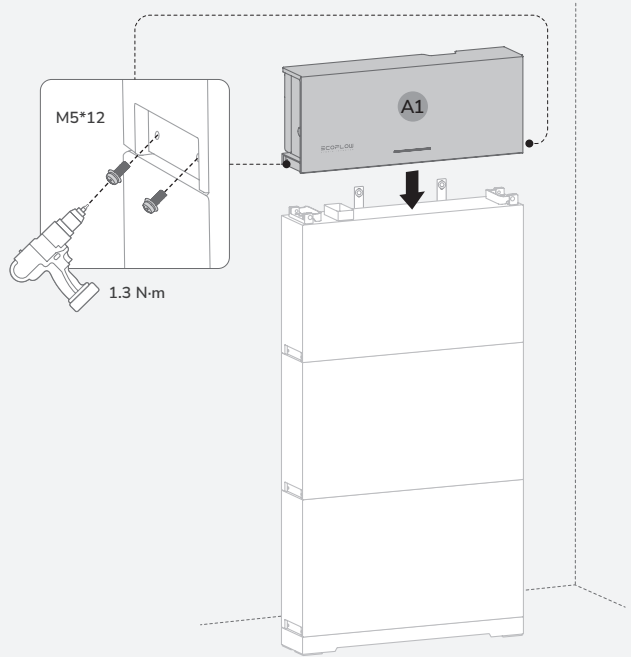

Method 2: (Optional) Wall Mounted

NOTICE

- For details about wall mounted installation, see the installation guide that comes together with the EcoFlow PowerOcean Wall-Mounted Battery Base.

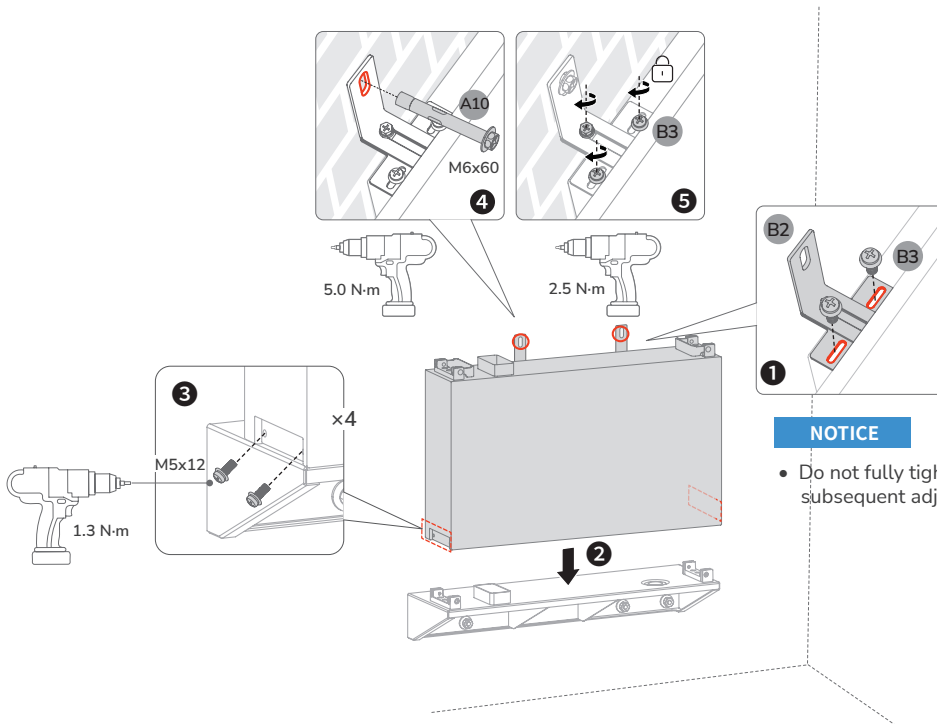

NOTICE

- Install the remaining batteries and the inverter as shown in the method 1.

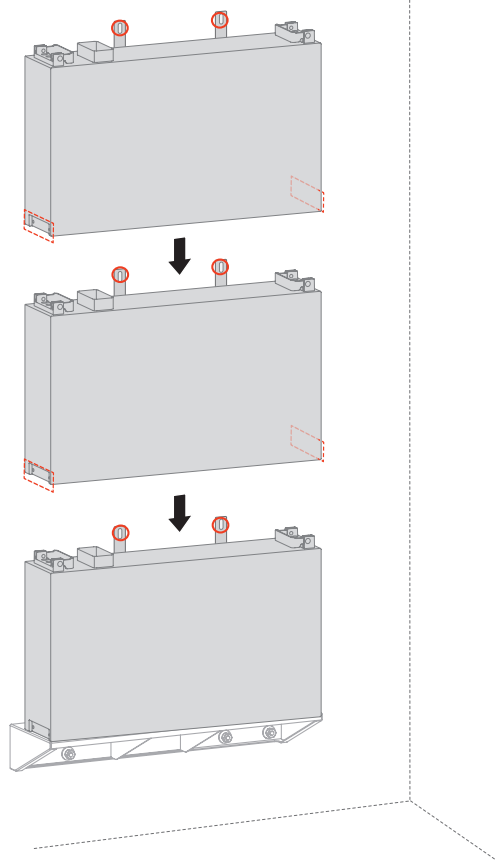

Electrical Connection

CAUTION

- All electrical connections must be carried out by a professionally trained and certified electrician.

NOTICE

- Please purchase cables that meet local certification standards.
- Do not remove the protective cap of unused terminals. Otherwise, the IP rating of the inverter will be affected.
- The cable colors shown in the figures are for reference only. Select an appropriate cable according to the local standards.

EcoFlow PowerOcean System

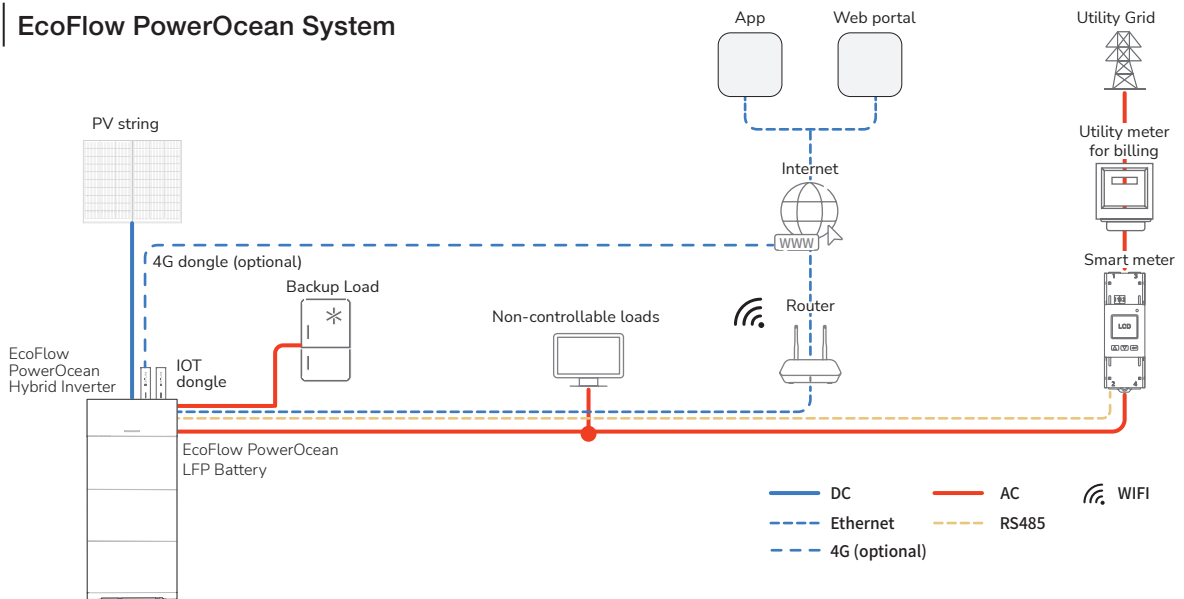

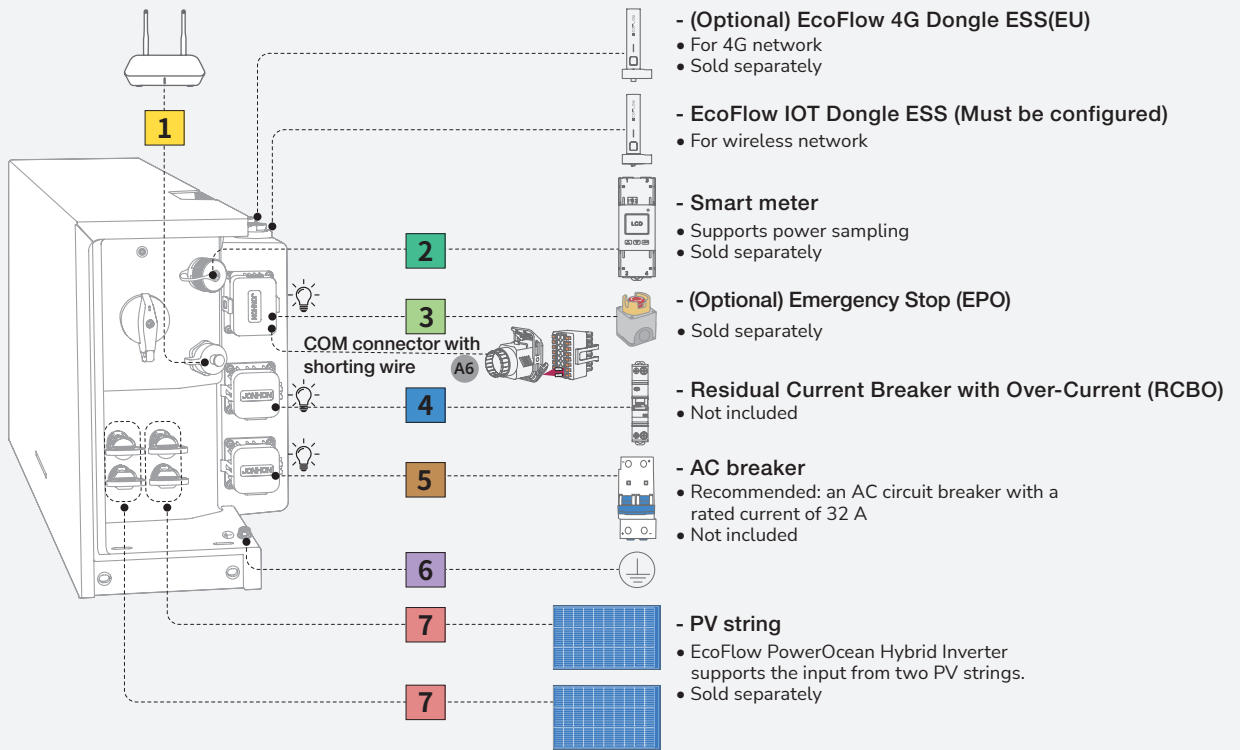

1 Ethernet cable (optional) CAT 5e or higher shielded network cable	4 Backup cable 6 mm ² to 8 mm ²	7 PV Input cable Conductor cross-sectional area: 4 mm ² to 6 mm ² with a rated voltage greater than or equal to 600V DC
2 Smart meter communication cable CAT 5E 8*0.2mm ²	5 Grid cable 6 mm ² to 8 mm ²	Connectors with JONHON trademark supplied by Avic Jonhon Optronic Technology Co., Ltd.
3 COM terminal communication cable-EPO (optional) Shielded Twisted Pair 2*0.5mm ²	6 PE cable 6mm ²	

| (Optional) Integrating Existing PV System to the EcoFlow PowerOcean System

EcoFlow PowerOcean system is compatible with any single/three-phase PV grid-tied system. An existing PV system can be integrated to be a PV Energy Storage System (ESS) by connecting to the GRID terminal of the PowerOcean hybrid inverter. The power generation from the existing PV inverter will be firstly provided to the loads and then charge the battery. When the feeding power of third-party inverter is less than about 200W, it will not charge the battery. With the self-powered mode of the EcoFlow PowerOcean system, the self-consumption rate of the new system, and the self-sufficiency rate of residential energy will be greatly improved, reducing electricity costs.

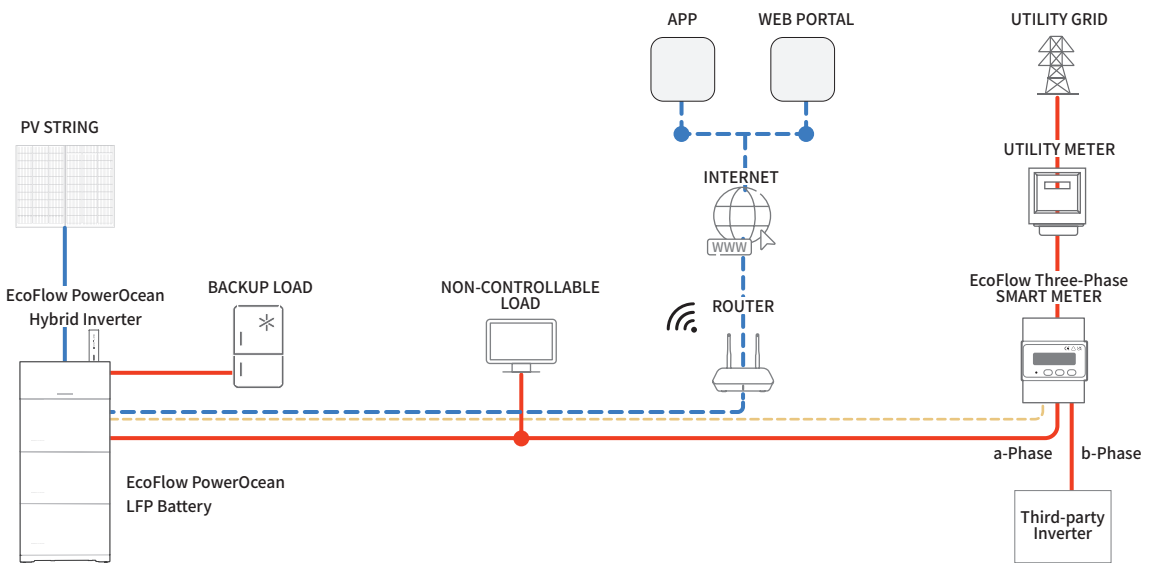

(Optional) EcoFlow PowerOcean System Cascading

NOTICE

- In the PowerOcean cascading scenario, the primary and secondary inverters are both EF HD-P1-(3K-6K)-S1, and a maximum of three EF HD-P1-(3K-6K)-S1 can be cascaded.
- In the PowerOcean cascading scenario, the three EF HD-P1-(3K-6K)-S1 connected to the power grid must meet the local power grid requirements.

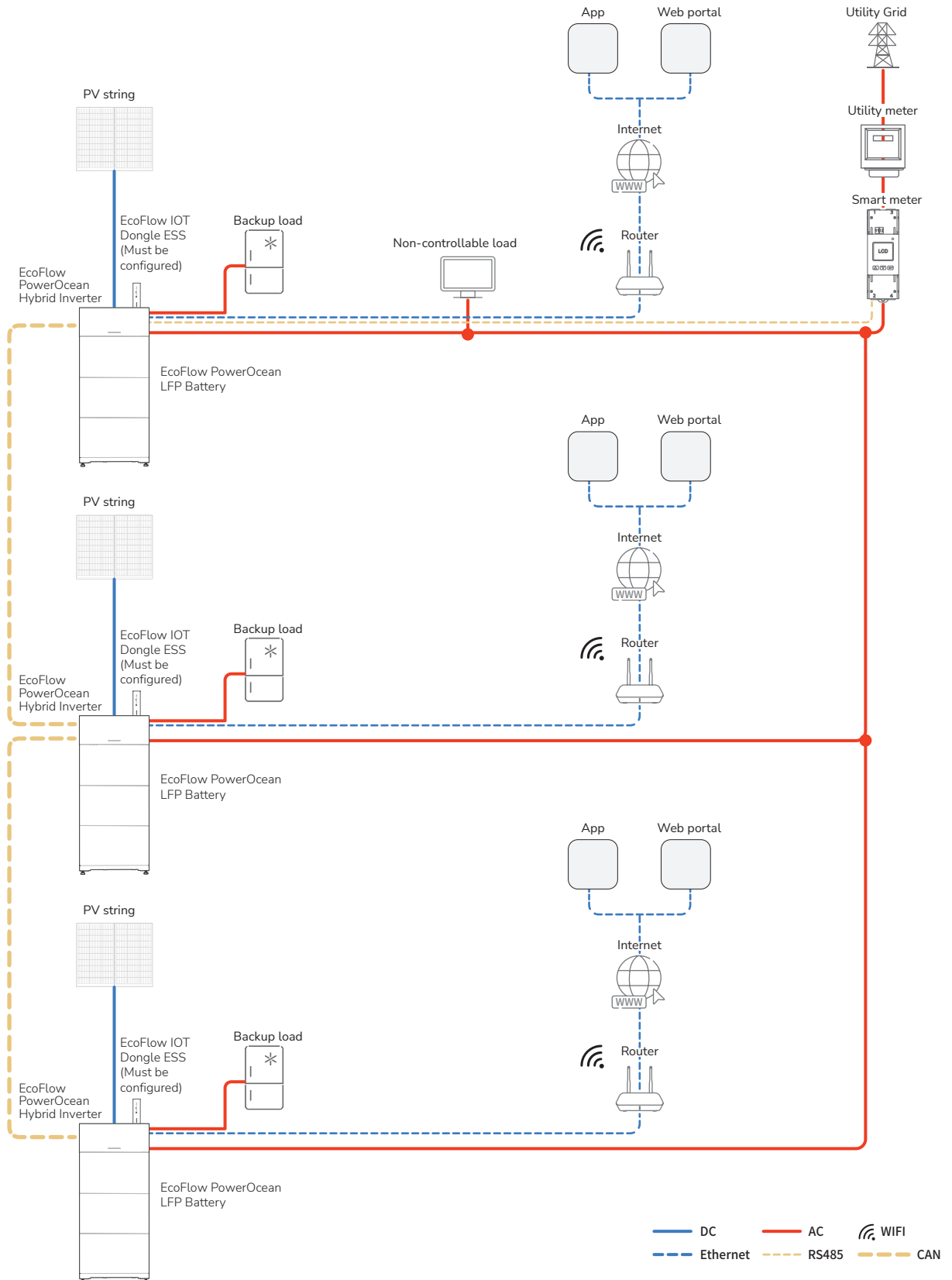

EcoFlow PowerOcean System Wiring Diagram

NOTICE

- N and PE cables should be separately wired in the Main Panel.
- A double-pole double-throw switch (DPDT for short) is recommended to be configured on the BACK-UP side for convenient maintenance.

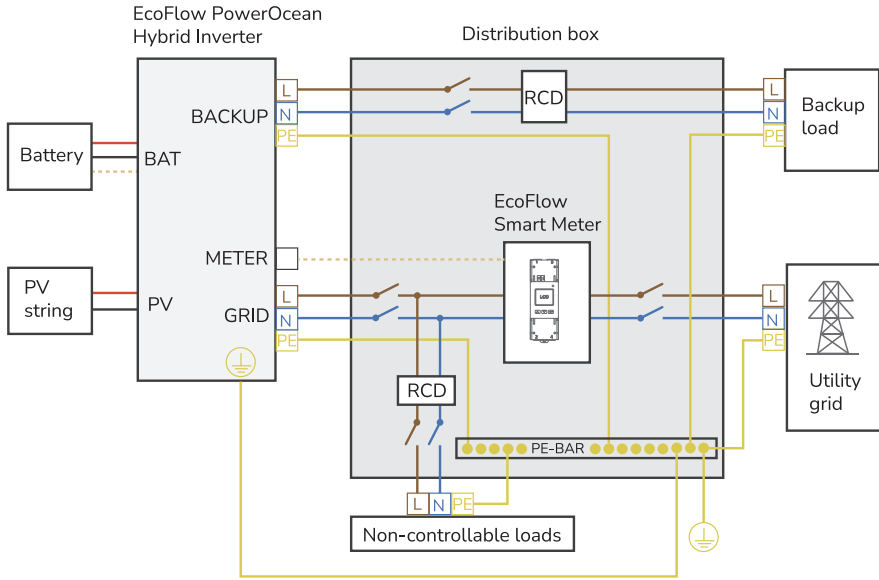

(Optional) EcoFlow PowerOcean Cascading Wiring Diagram

2 Inverters Cascading Wiring Diagram

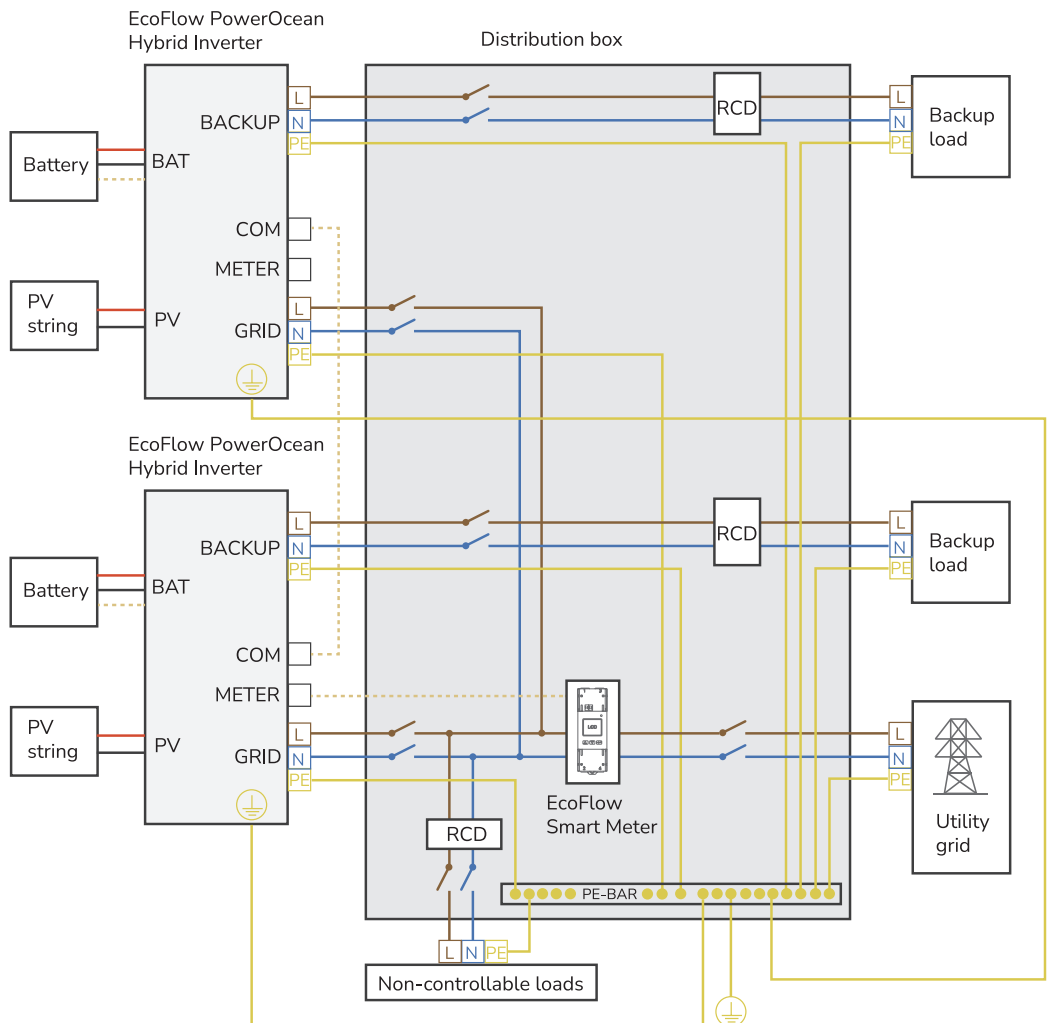

3 Inverters Cascading Wiring Diagram

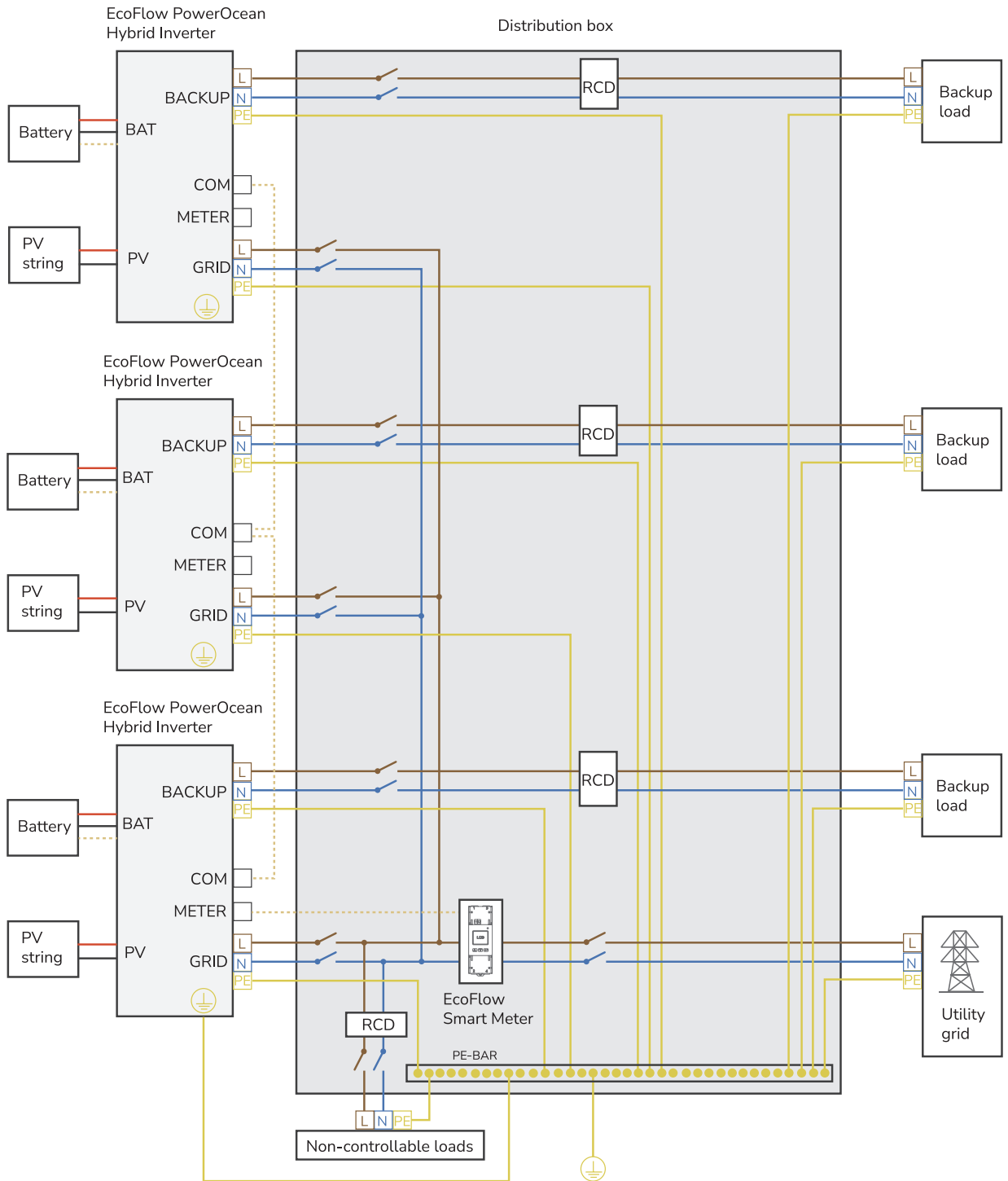

Connecting PE Cables

NOTICE

- Ensure that the PE cable is connected securely.
- Wrap the wire crimping area with heat shrink tubing or insulation tape. The heat shrink tubing is used as an example.
- When using a heat gun, protect the equipment from being scorched.
- It is recommended that silica gel or paint be used around the ground terminal after the PE cable is connected.

1  x1

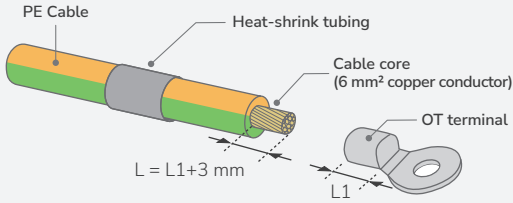

2

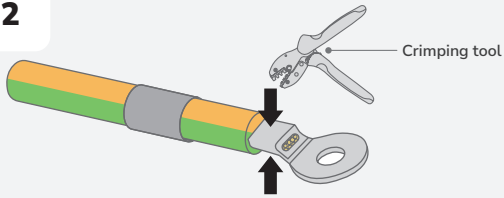

3

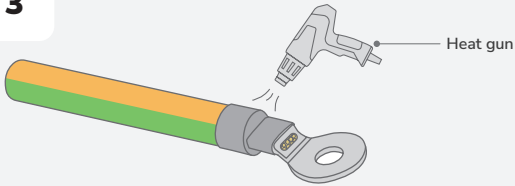

4

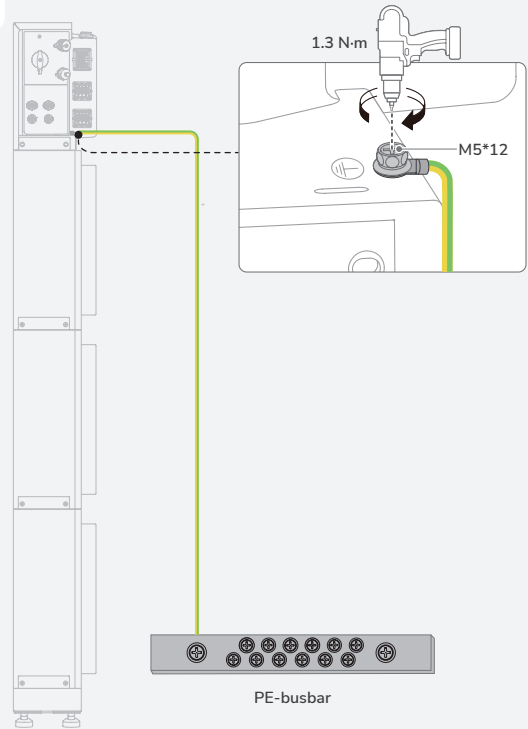

Connecting GRID Cables

CAUTION

- Before installing, operating, and maintaining the equipment, always disconnect it from all power.
- Do not connect loads between the inverter and the AC switch that directly connects to the inverter.
- Ground the PE hole of GRID connector and the equipment enclosure.
- Do not connect the GRID connector to the BACKUP terminal of the inverter.

NOTICE

- RCD with rated residual operating current of 100 mA (AC-GRID) and 30mA (AC-BACKUP) would be recommended if there is additional protection by RCD shall be provided for local electrical installation, while the use of an RCD with lower rated residual operating current is also permitted if it is required by the specific local electrical codes.
- In the PowerOcean cascading scenario, each cascaded EF HD-P1-(3K-6K)-S1 needs to be connected to an RCD alone. Do not connect all cascaded EF HD-P1-(3K-6K)-S1 to the same RCD of higher rated current.

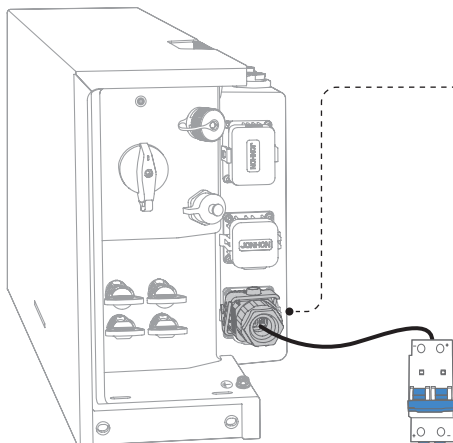

GRID terminal

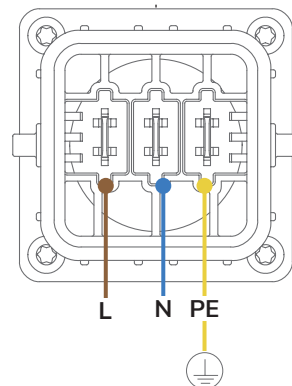

L · Live line
N · Neutral wire
PE · Ground wire

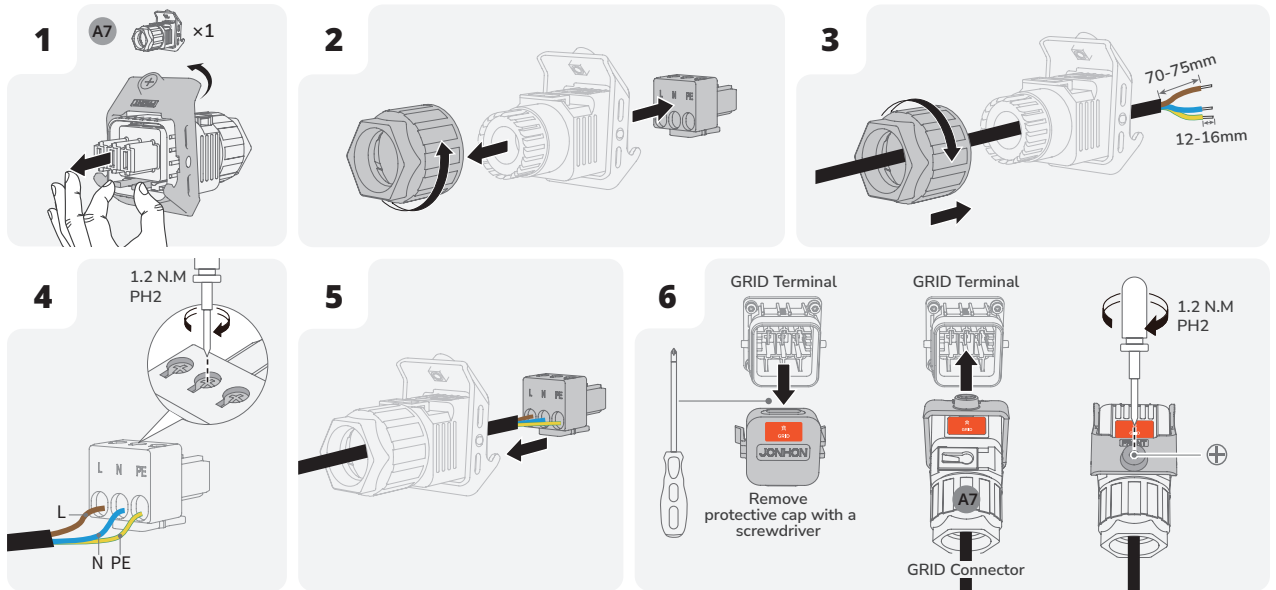

Connecting BACKUP Cables

⚠ CAUTION

- Before installing, operating, and maintaining the equipment, always disconnect it from all power.
- Do not connect the BACKUP connector to the GRID terminal of the inverter.
- It is not recommended to connect loads with high starting power to BACKUP terminal, such as vacuum cleaner, air conditioner, etc.

NOTICE

- RCD with rated residual operating current of 100 mA (AC-GRID) and 30mA (AC-BACKUP) would be recommended if there is additional protection by RCD shall be provided for local electrical installation, while the use of an RCD with lower rated residual operating current is also permitted if it is required by the specific local electrical codes.
- In the PowerOcean cascading scenario, each cascaded EF HD-P1-(3K-6K)-S1 needs to be connected to an RCD alone. Do not connect all cascaded EF HD-P1-(3K-6K)-S1 to the same RCD of higher rated current.

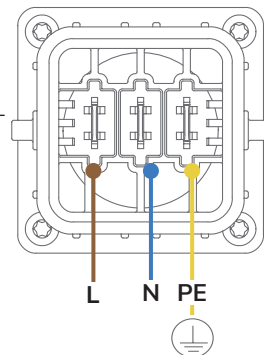
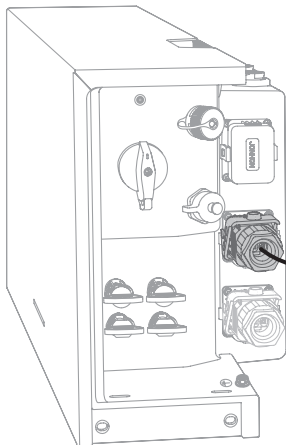

BACKUP terminal

- L · Live line
- N · Neutral wire
- PE · Ground wire

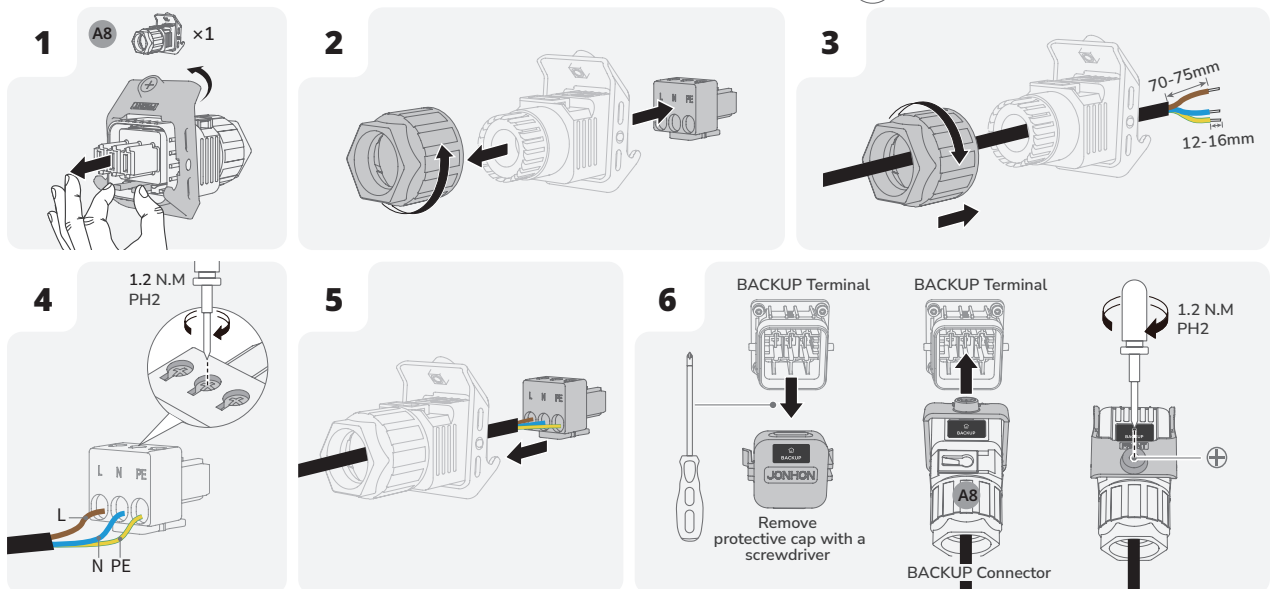

Installing COM Connector With Shorting Wire

NOTICE

- COM terminal supports logic interface connection. Logic interface is required by some local regulations that can be operated by a simple switch or contactor.
- When the switch is closed, the inverter can operate normally. When the switch is opened, the inverter will reduce its active power to zero within 5s.
- Pin14 and Pin16 of COM terminal is used for the logic interface connection.
- If no additional EPO is configured, PIN 14 and PIN 16 must be connected using a wire.

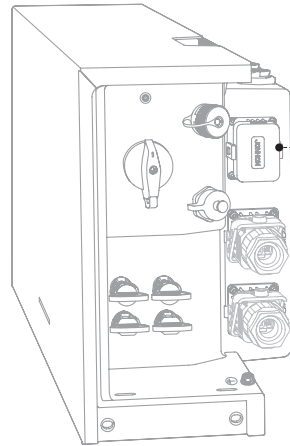

COM terminal

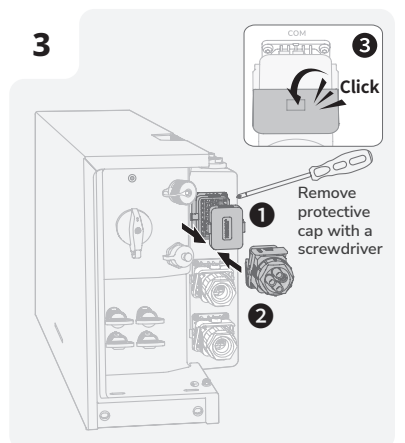
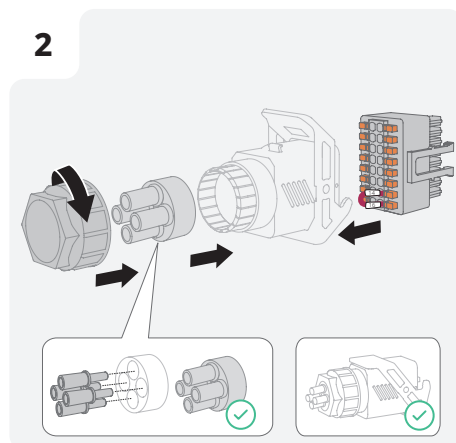
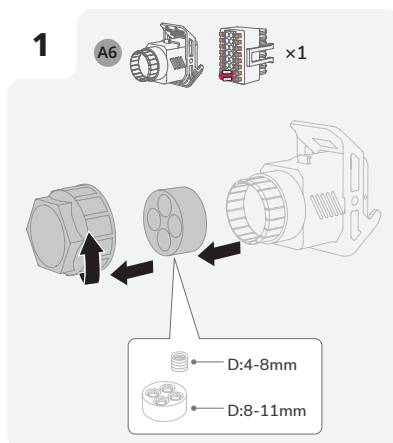
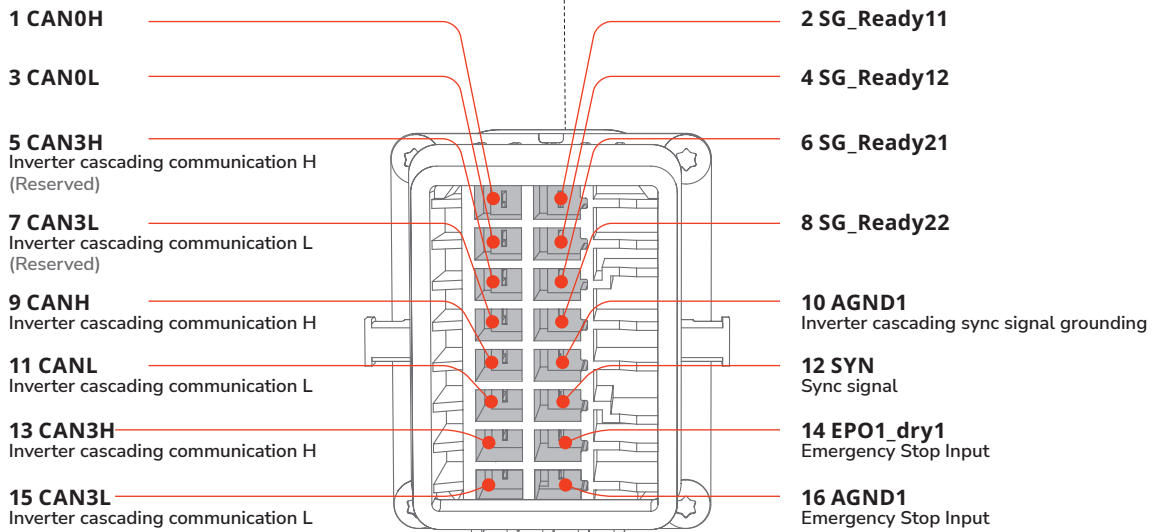

(Optional) Installing Emergency Stop (EPO)

NOTICE

- Before installing EPO, please remove the shorting wire between PIN14 and PIN16.
- For more details about Emergency Stop, please refer to the user manual that comes together with it.

1 **A6**  x1

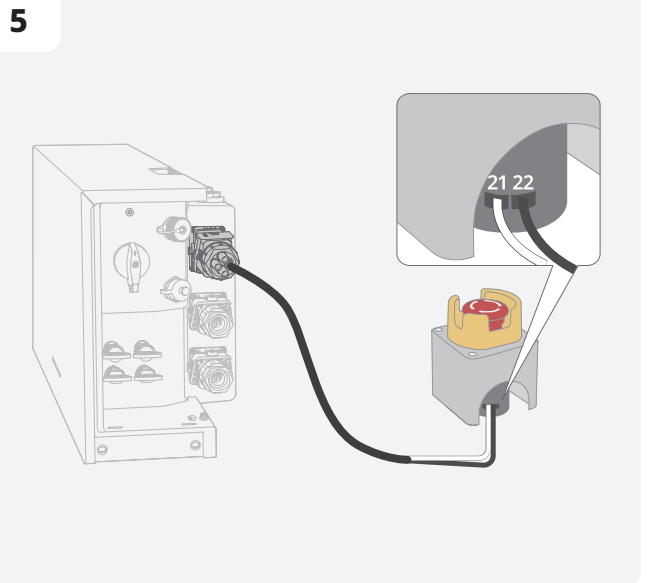
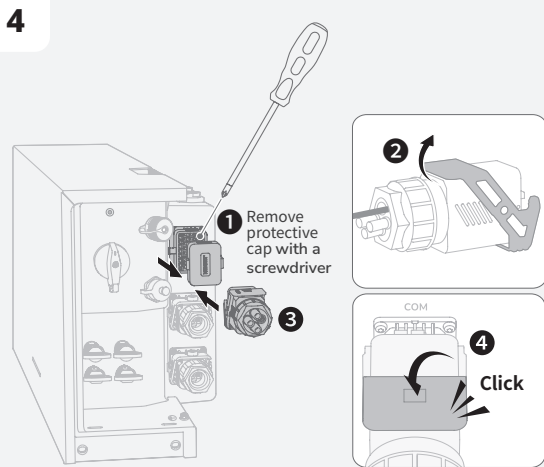
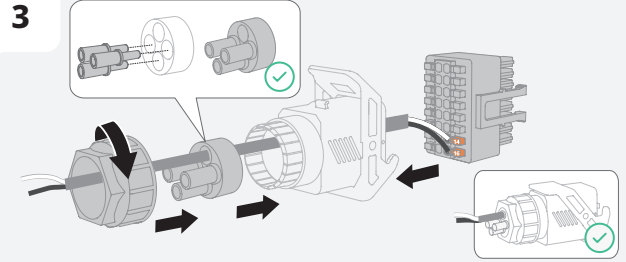
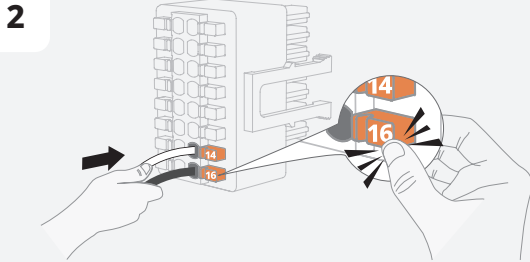
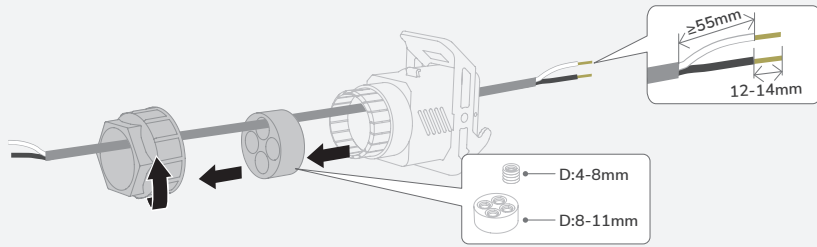

(Optional) Connecting Communication Cables between the cascaded EF HD-P1-(3K-6K)-S1



Crimping tool
(for tubular terminal)

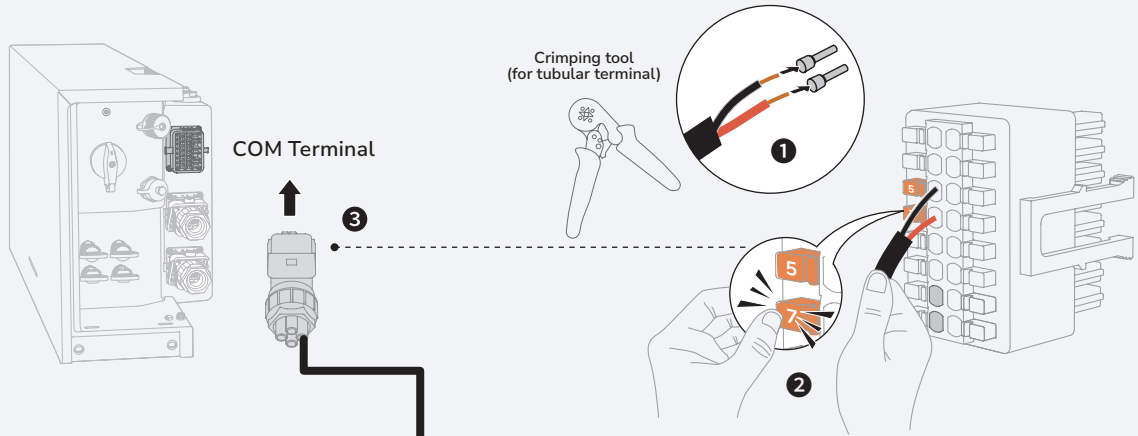

Connection between 2 cascaded EF HD-P1-(3K-6K)-S1

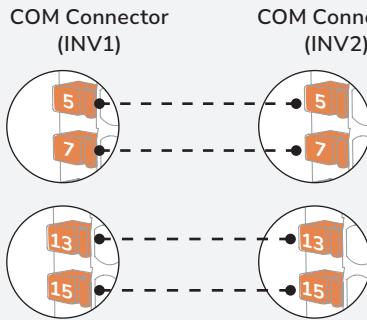

Connection between 3 cascaded EF HD-P1-(3K-6K)-S1

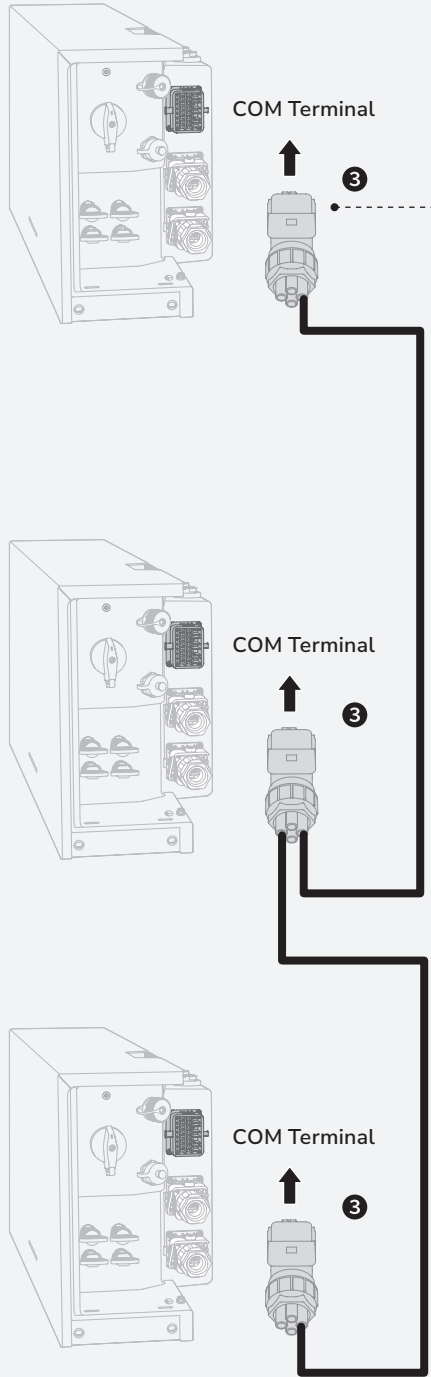
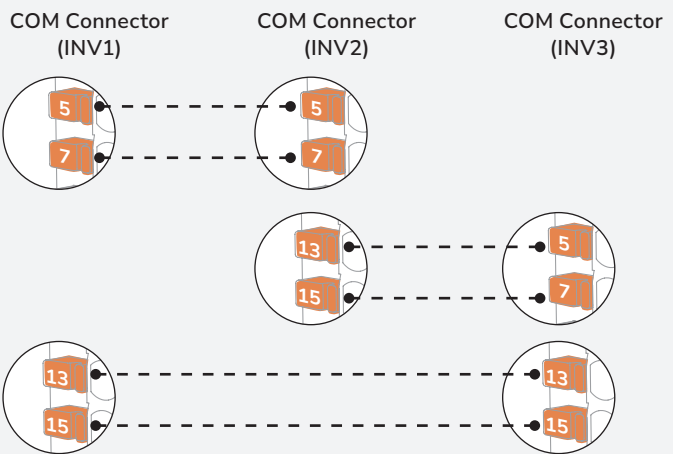

Connecting PV Input Cables

⚠ DANGER

- Before connecting the PV input cables, ensure AC switch connected to the inverter and the PV SWITCH on the inverter are OFF. Failing to do so may result in electric shocks.
- The PV string will generate lethal high voltage when exposed to sunlight. Disconnect the PV cable of PV string before connecting DC power.
- Before connection, ensure the polarity of the output of the PV array matches "PV+/"PV-" symbols.
- Before connecting the PV input cables, ensure that the impedance between the positive/negative terminals of the PV string and earth are larger than 1 MΩ. Do not ground the PV array positive/negative hole.
- When the inverter is running, it is not allowed to work on the PV input cables, such as connecting or disconnecting a PV string or a PV module in a PV string. Failing to do so may cause electric shocks.
- Do not remove Solarlok SAFE-TE Connectors of unused PV input terminal. Failing to do so may result in electric shocks.
- Ensure that the maximum DC voltage and the maximum short-circuit current of any string do not exceed the allowed range specified in the "Technical Parameters" of the User Manual.

NOTICE

- In order to avoid malfunction, please do not connect any PV modules that have a risk of leakage current to the inverter.
- In order to avoid lightning damage to the inverter, it is recommended to add a surge protection switch at the PV junction box.
- After the positive and negative connectors snap into place, slightly pull the PV input cables back to ensure that they are connected securely.
- It is not recommended that connect different brands or models of PV modules to one MPPT circuit, or connect PV modules of different orientation or angles to one PV string.

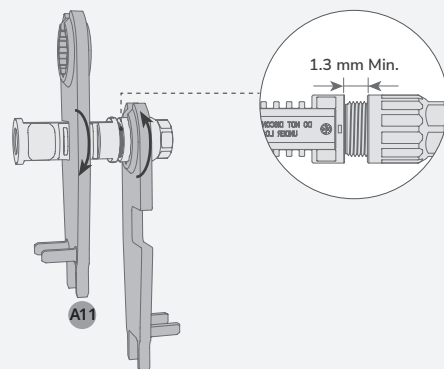
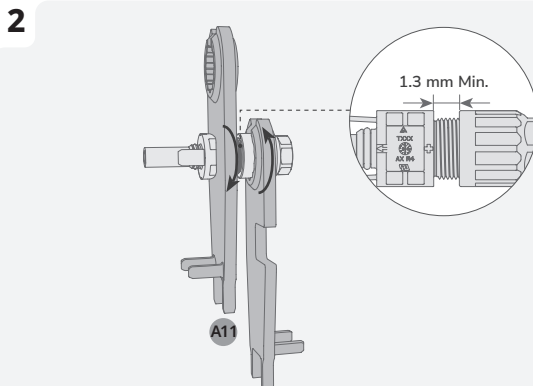
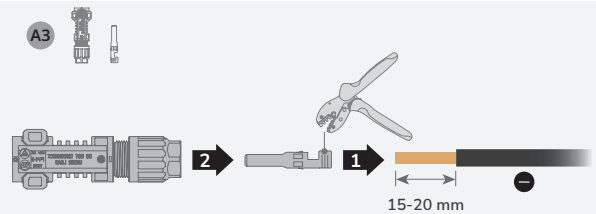
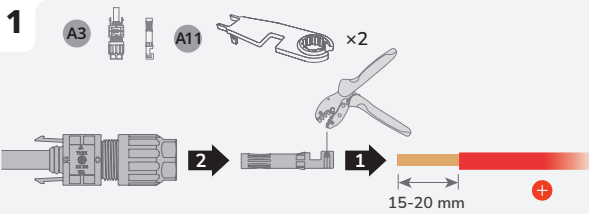
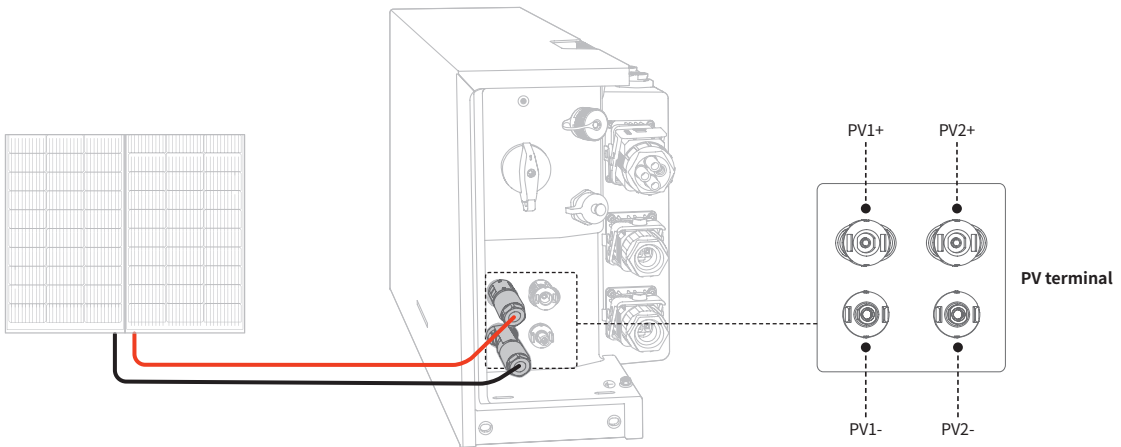

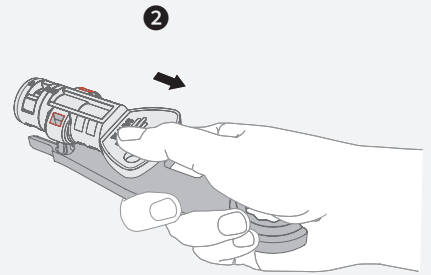
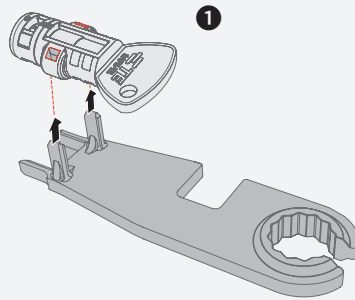
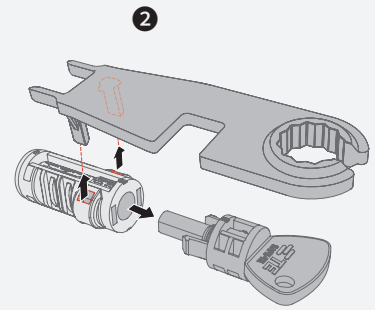
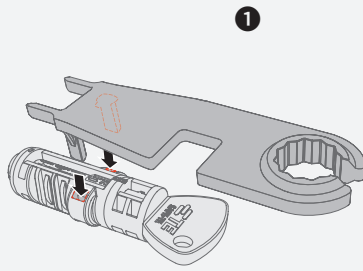
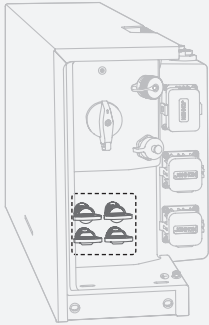

REMOVE SOLARLOK SAFE-TE CONNECTORS

A11  ×1

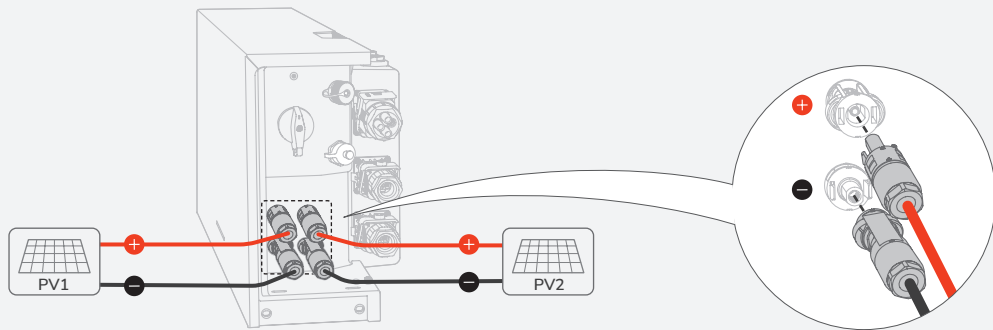

CONNECT TO THE INVERTER.



 Set the multimeter to DC gear to measure the voltage at the DC position. If the voltage is a negative value, the PV input polarity is incorrect and needs correction. If the voltage is greater than 600 V, too many PV modules are configured to the same string. Remove some PV modules.

If the PV input cable is reversely connected and the PV SWITCH is set to ON, first set the PV SWITCH to the OFF position, then remove the positive and negative connectors, and correct the polarities of the PV input cables.

REMOVING THE PV TERMINAL



WARNING

- Before removing the positive and negative connectors, ensure that the PV SWITCH is OFF.

A11  ×1

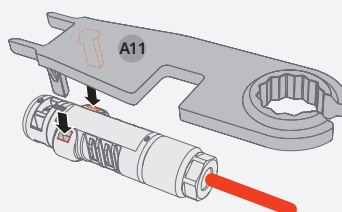

Connecting Smart Meter

NOTICE

- It is recommend to use of CAT5 or higher rating network cable.
- Smart meter is sold separately, which has been preset parameters before delivered. Do not modify the relevant parameters.
- The compatibility of this product with smart meters may vary by regions and versions. For detailed instructions on the installation and wiring scheme of the smart meter for this product, please refer to the guide that comes together with the meter.
- As a result of the design change, there are two versions of the METER port of delivered inverters. The actual delivery may vary.

Version 1

SMART METER INSTALLATION

- METER SAMPLING**
Access the home mains and connect the smart meter as shown in the diagram.
- METER COMMUNICATION**
Connect communication port 11, 12 on the meter to the METER port of inverter.

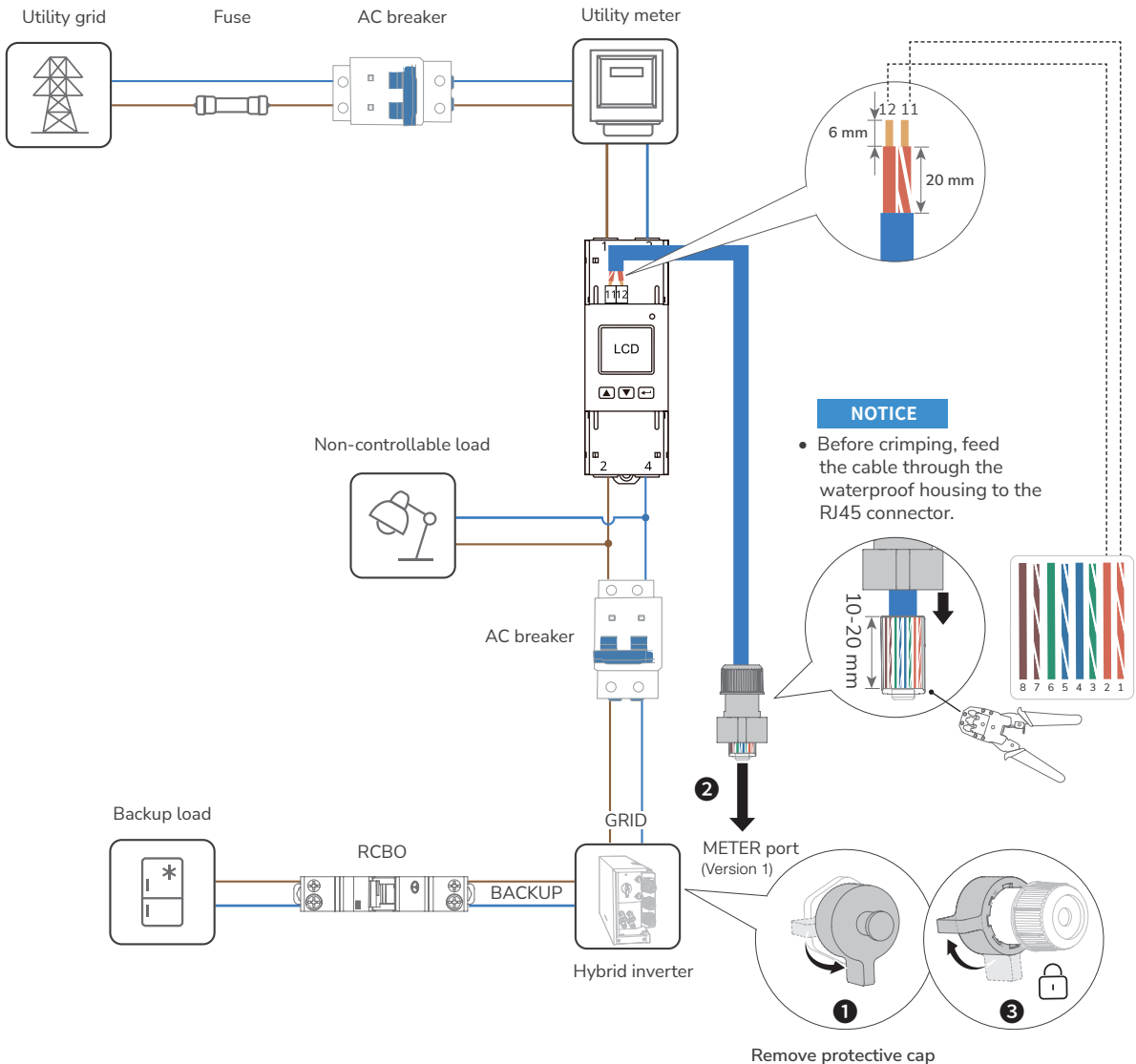
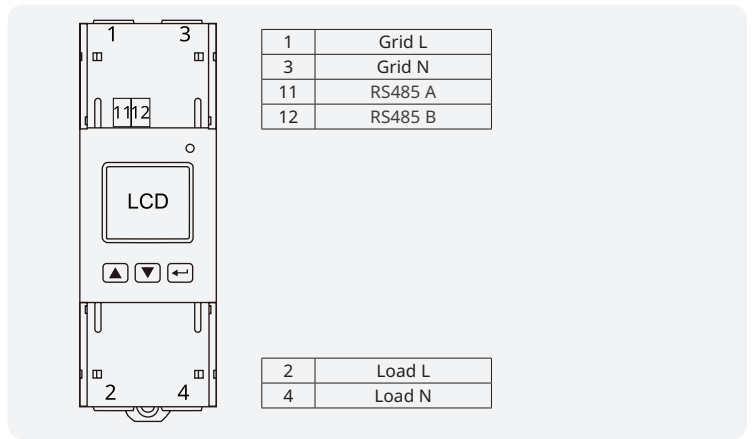

SMART METER (WITH EXTERNAL CT) INSTALLATION

1 METER SAMPLING
Access the home mains and connect the smart meter as shown in the diagram.

2 METER COMMUNICATION
Connect communication port A, B on the meter to the METER port of inverter.

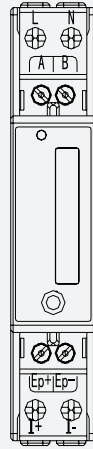

L	Grid L
N	Grid N
A	RS485 A
B	RS485 B

I+	Grid L CT
I-	

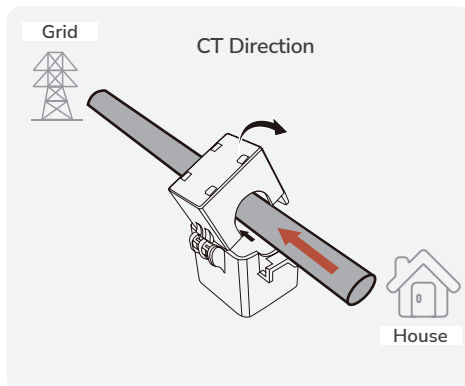
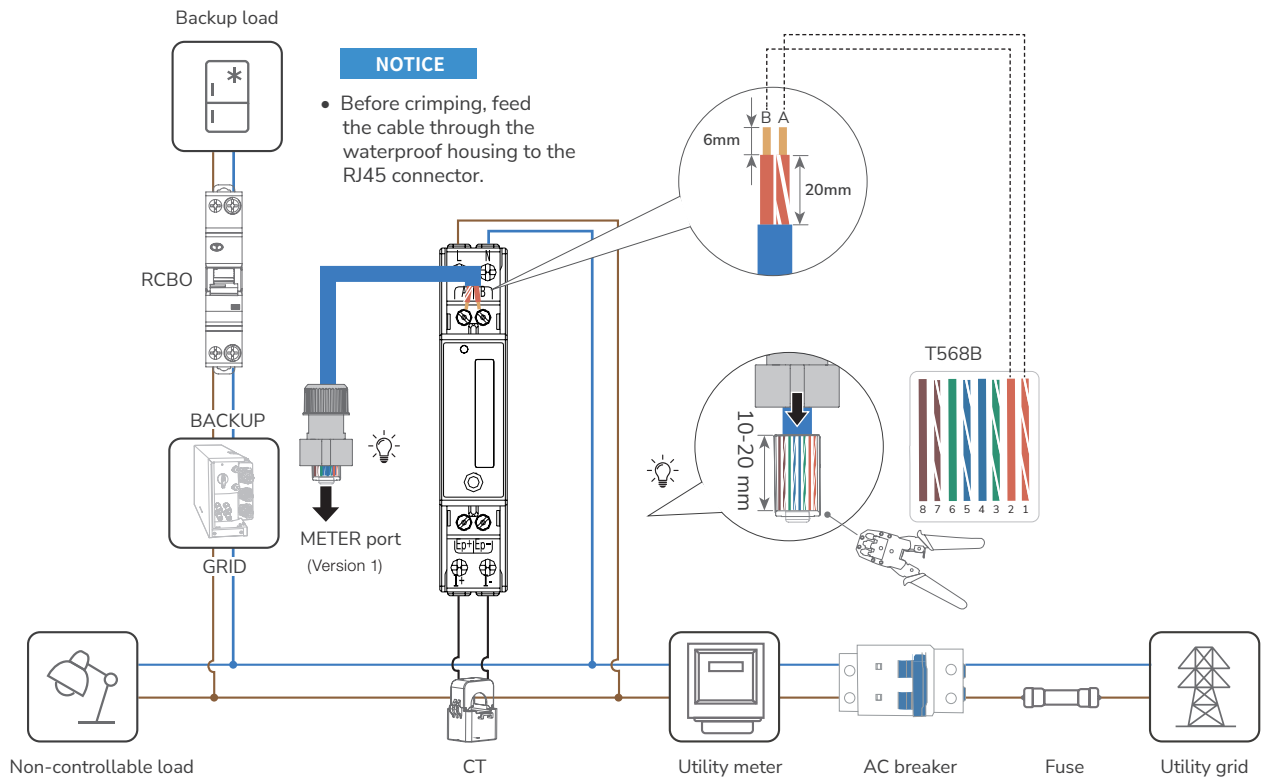

Version 2

ASSEMBLING A METER PORT CONNECTOR (RS485)

1 **A5** x1

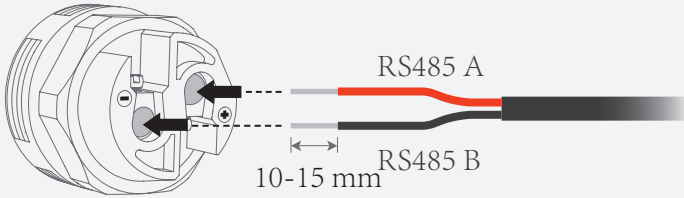

2 **(SL3)**

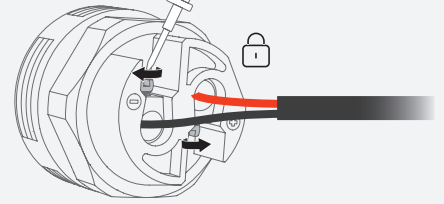

3 (Version 2) METER port

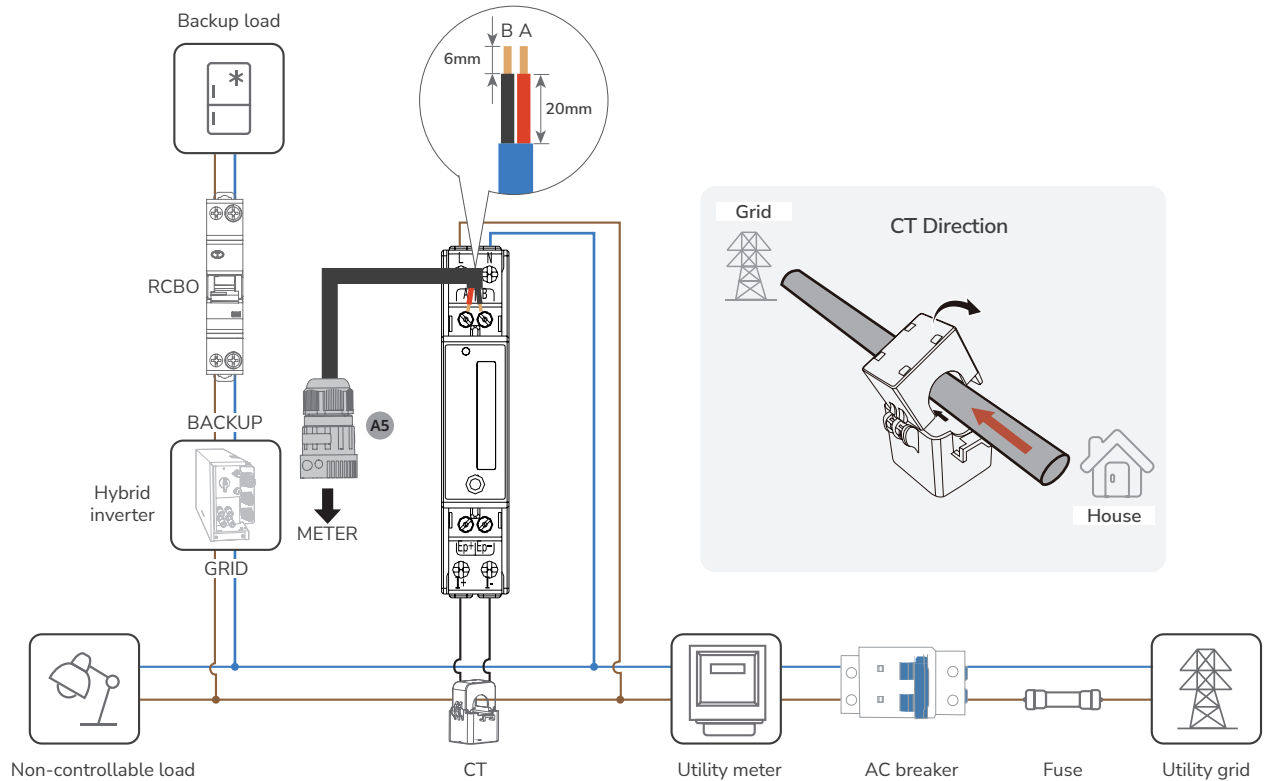
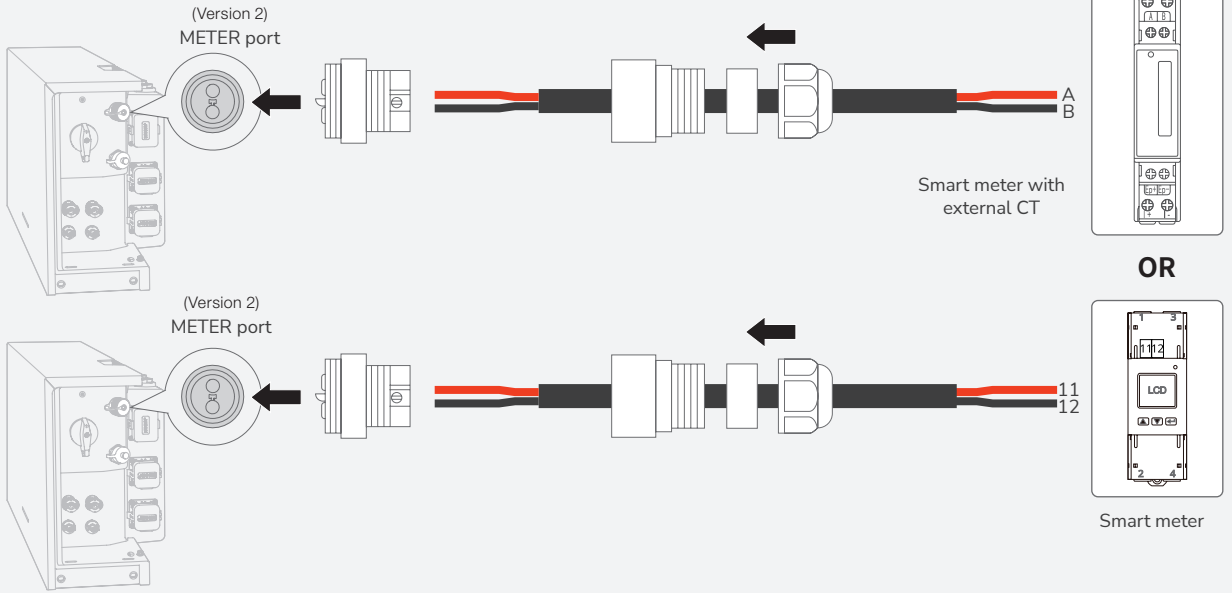

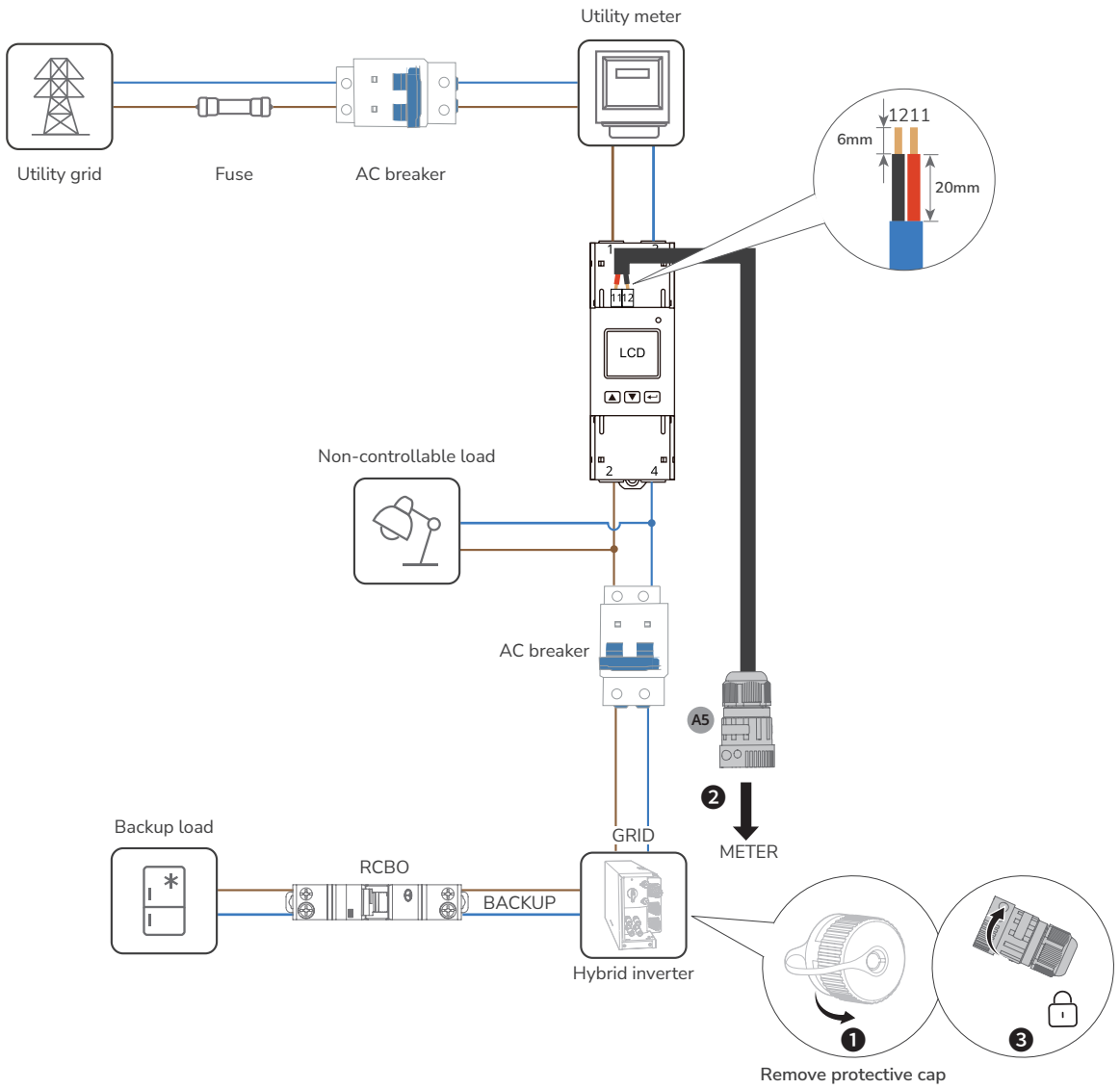

(Optional) Connecting Three-Phase Smart Meter to PowerOcean and Third-Party Inverter

NOTICE

- It is recommend to use of CAT5 or higher rating network cable.
- Smart meter is sold separately, which has been preset parameters before delivered. Do not modify the relevant parameters.
- The compatibility of this product with smart meters may vary by regions and versions. For detailed instructions on the installation and wiring scheme of the smart meter for this product, please refer to the guide that comes together with the meter.
- As a result of the design change, there are two versions of the METER port of delivered inverters. The actual deliverables may vary.

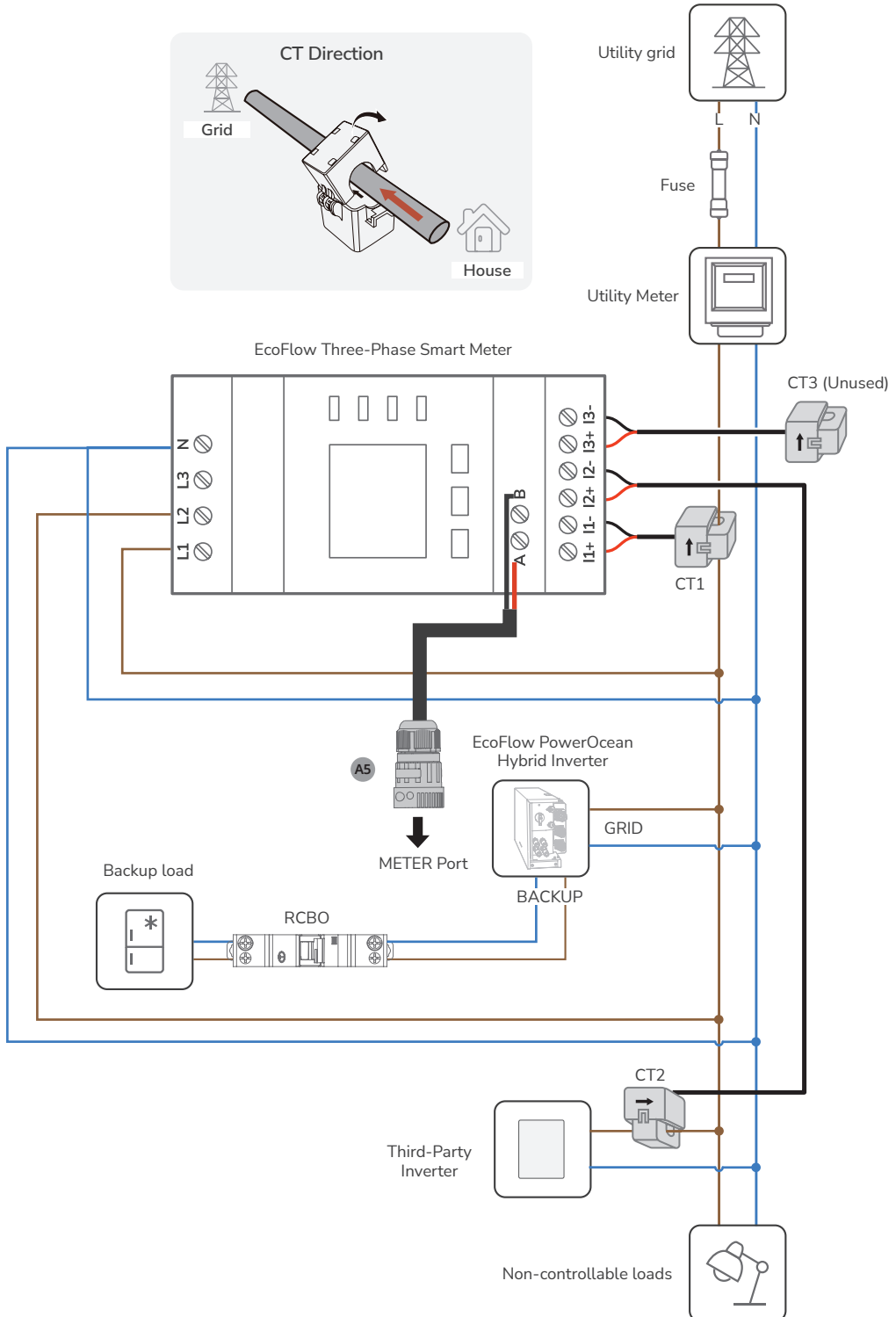

Connecting to Internet

NOTICE

- Use shielded CAT 5 or higher rating network cable for stable connection.

• **METHOD 1: VIA A WIRED NETWORK**

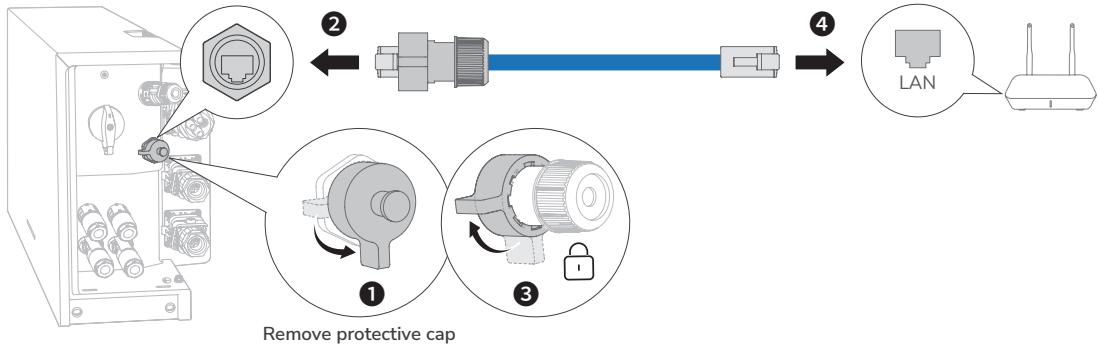

1 A4 x1

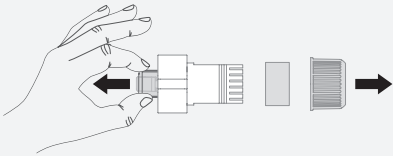

2 Both ends of the network cable use the T568B wiring standard.

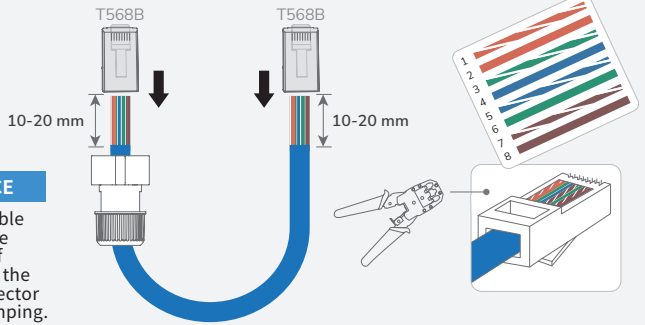

3 Test network cable connection. If the LEDs of the two RJ45 ports light up in sequence, it indicates that the network cable is correctly wired and should be fully operational.

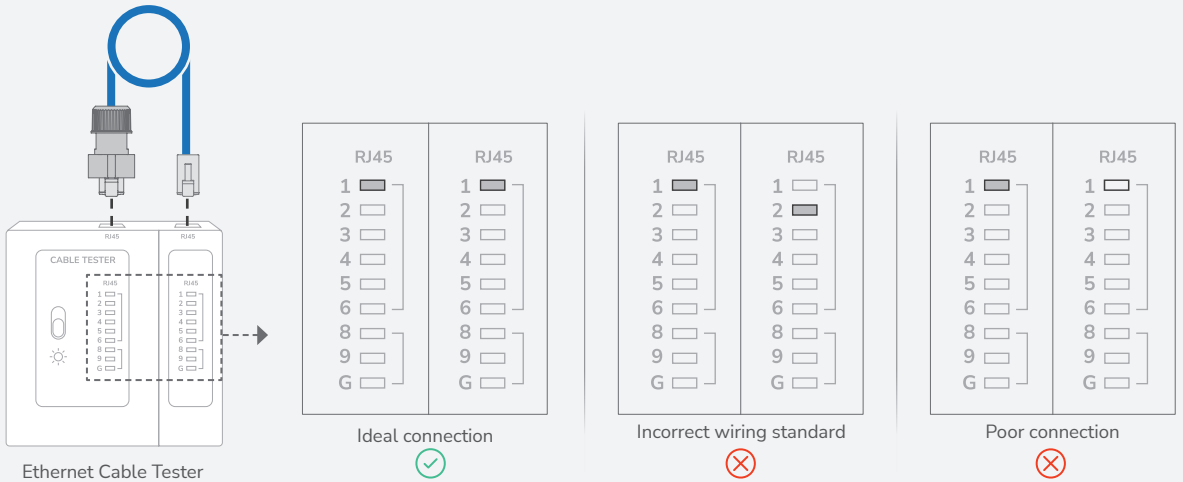

• **METHOD 2: VIA A WIRELESS NETWORK**

Refer to the System Commissioning section in this guide to connect to a wireless network.

Installing trim cover

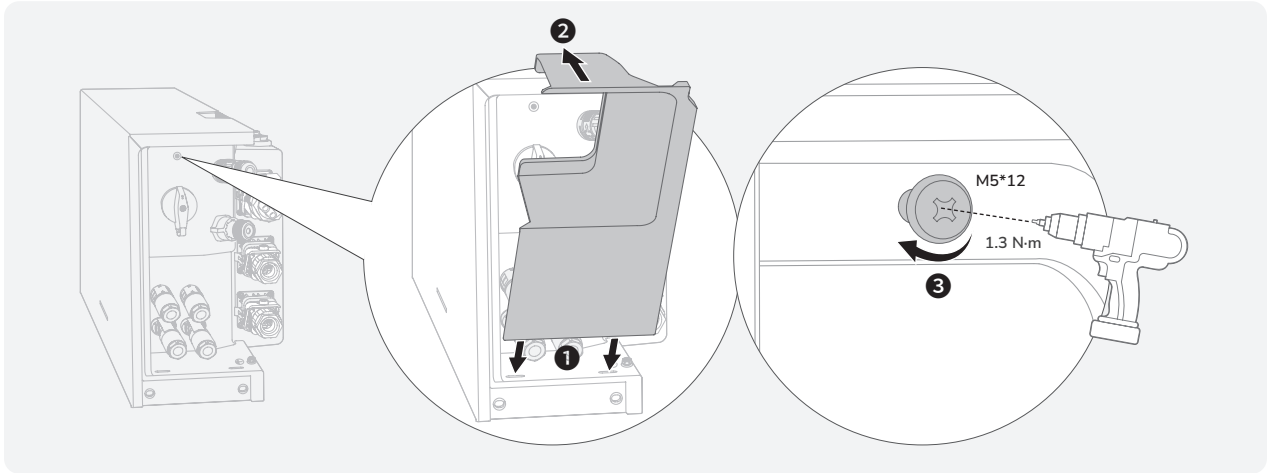

Installing EcoFlow IOT Dongle ESS (Must be configured)

NOTICE

- For more details about EcoFlow IOT Dongle ESS, please visit following website to access user manual: <https://enterprise.ecoflow.com/eu/documentation>

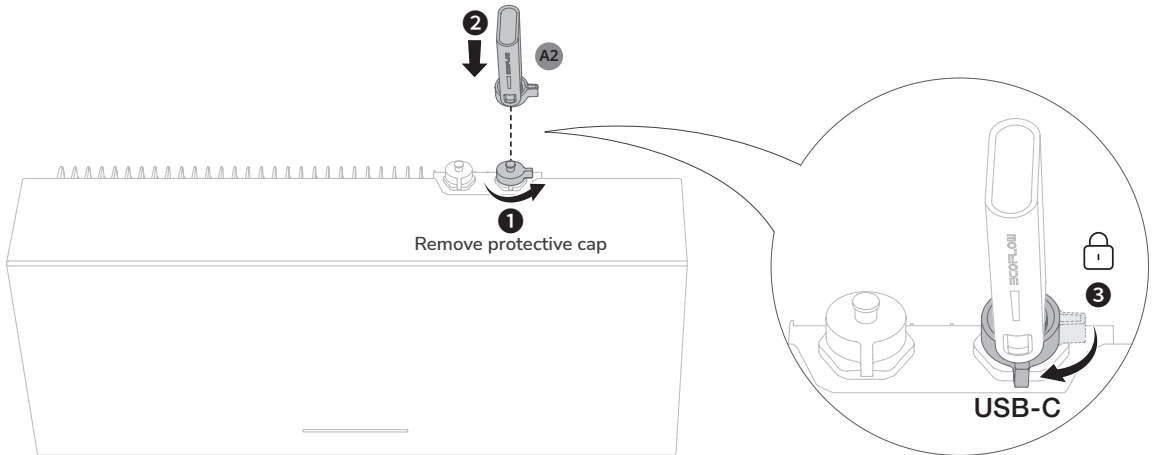

(Optional) Installing EcoFlow 4G Dongle ESS(EU)

NOTICE

- For more details about EcoFlow 4G Dongle ESS(EU), please refer to the user manual.

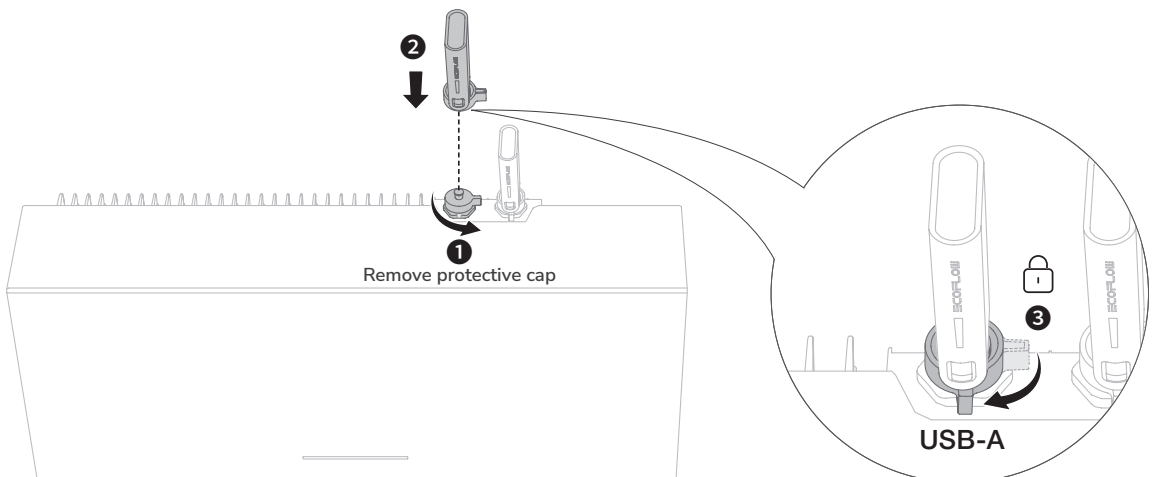

System Commissioning

Checking before Power-On

Check Item	Acceptance criteria
Equipments	Equipments are installed correctly and securely.
Cables routing	Cables are routed properly as required by the customer.
Cable tie	Cable ties are evenly distributed and no burr exists.
Grounding	The PE cable is connected correctly, securely, and reliably.
Switch	All the switches connecting to the system are OFF.
Cable connection	The AC/DC power cable, battery cable, and communication cable are connected correctly, securely, and reliably.
Unused terminal and port	Unused terminals and ports are locked by watertight covers.
Installation environment	The installation space is proper, and the installation environment is clean and tidy.

System Power-On

PROCEDURE (ON-GRID AND PV MODULE CONFIGURED)

1. Turn on the AC switch between the inverter and the power grid.
2. Set the PV SWITCH on the side of the inverter to ON position.
3. Observe the LED to check the inverter operating status.

PROCEDURE (OFF-GRID AND NO PV MODULE CONFIGURED)

1. Turn on the AC switch between the inverter and the power grid.
2. Set the PV SWITCH on the side of the inverter to ON position.
3. After commissioning, press and hold for 5 seconds the BATTERY ON/OFF button.
4. Observe the LED to check the inverter operating status.

System Power-Off

WARNING

Before installing, operating, and maintaining the equipment, always disconnect it from all power.

1. Send a shutdown command on the App.
2. Turn off the AC switch between the inverter and the power grid.
3. Set the PV SWITCH on the side of the inverter to OFF position.
4. (Optional) Secure the PV SWITCH with a lock to prevent accidental startup. The lock is prepared by the customer.
5. Press and hold the BATTERY ON/OFF button of the junction box for 10 seconds, until the indicator is off.
6. Sequentially disconnect GRID cables, BACKUP cables, PV input cables, communication cables and all modules connecting to the system.

LED Indicators

LED Indicator	Symbol Conventions	
ON		Steady White
		Blinking White
		Carousel White
		Steady Orange
		Blinking Orange
OFF		OFF

Power On/Off Status	Description
	System startup
	System shutdown

Charge Status	Description
	0-25%
	25-50%
	50-75%
	75-99%
	100%

Discharge/Standby Status	Description
	<5%
	5-25%
	25-50%
	50-75%
	75-100%

Over-the-air Updates Status	Description
	Over-the-air update is in progress

Faulty Status	Description
	Abnormal electrical connection. Check if all equipment is installed correctly and securely.
	Abnormal smart meter communication.
	Abnormal IoT communication.
	Battery is faulty.
	Abnormal battery communication.
	Converter is faulty.
	Abnormal converter communication.

NOTICE

- If the LED indicates a faulty status, visit the EcoFlow Pro app to retrieve the error code for troubleshooting.

System Commissioning

1 DOWNLOAD AND INSTALL ECOFLOW PRO APP (FOR INSTALLER ONLY)

Scan the QR code or download at:
<https://download.ecoflow.com/ecoflowproapp>



2 CREATE ACCOUNT

a. Create company account

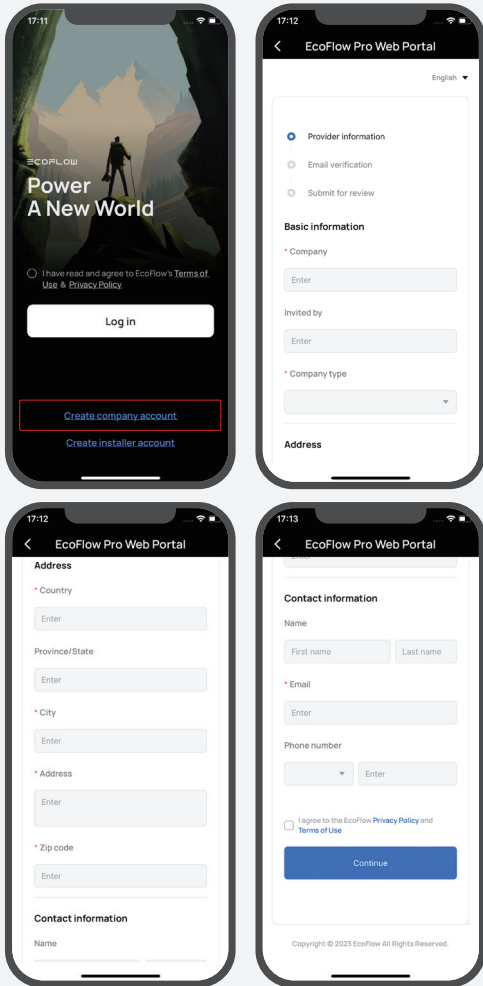

b. Create installer account

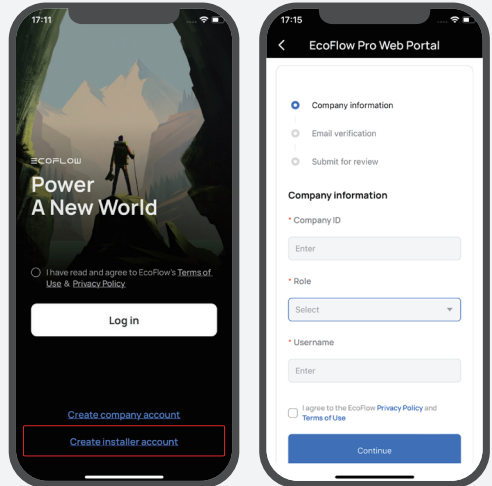

3 LOG IN

Enter the installer account and password.

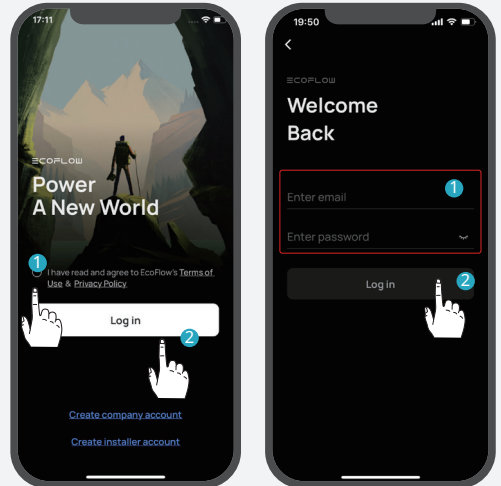

4 ADD DEVICE

You can connect to the system via Bluetooth or Wi-Fi.

a. Connect to the system via Bluetooth.

Click **Add System** to automatically search for bluetooth devices nearby, and click **EcoFlow PowerOcean Single Phase** to connect, then click **Complete** to proceed.

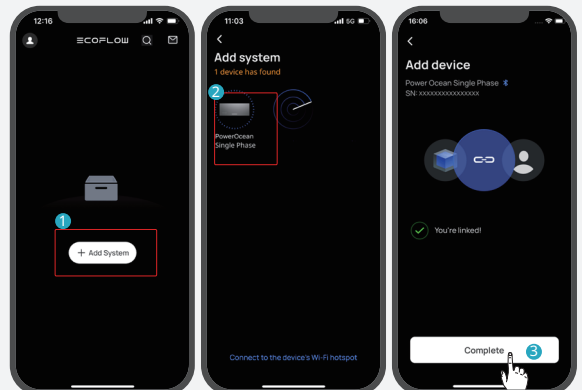

b. Connect to the system via Wi-Fi

1. Click "Add System" and then click "Or connect to the system's Wi-Fi" to access to your phone's Wi-Fi settings.
2. Find "PowerOcean_xxxx" and click it to enter the password for the Wifi, then click "Join". The password is the last 8 digits of the serial number of the inverter.

 You can find the serial number (S/N) in the product nameplate.

3. After successfully connected your phone to "PowerOcean_ xxxx", tap the "EcoFlow Pro" on the top left of your phone's Wi-Fi setting page to shift back and proceed to commissioning.

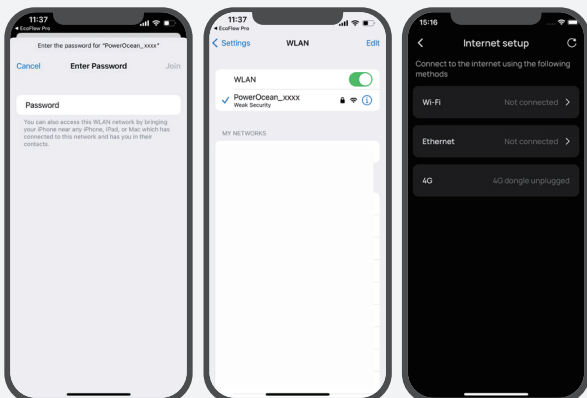
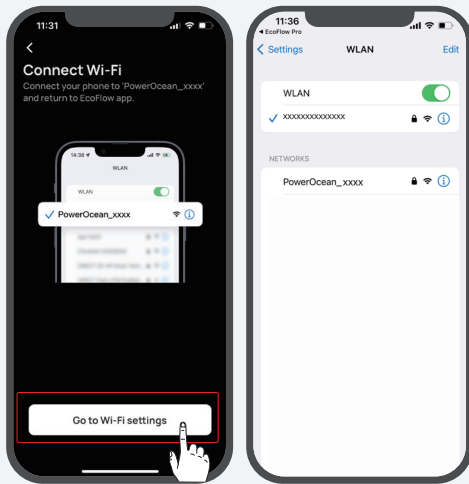
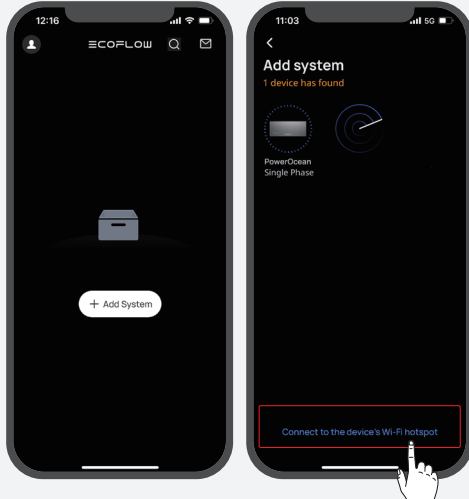

5

COMMISSIONING

After bound device successfully, the device enters the four-step commissioning process.

Step1: Internet Setup

click **Internet Setup** to start the network configuration.

Method 1: Wi-Fi

Click **WiFi**, select the appropriate WiFi name and enter the password and click **continue**.

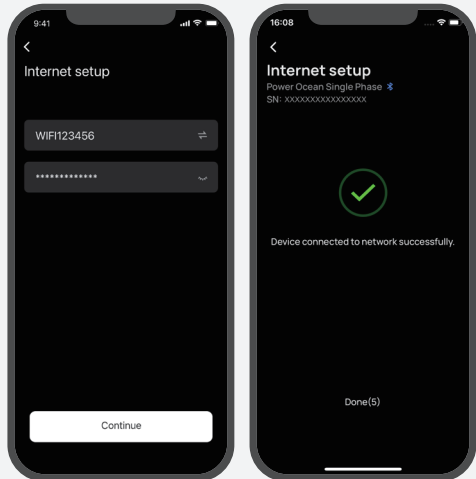
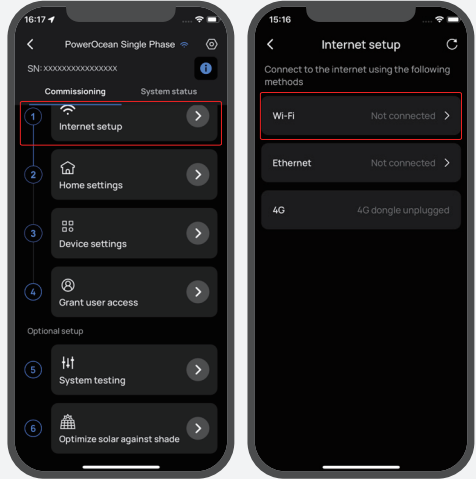

Method 2: Ethernet

Connect the system to a router using a network cable, wait a minute before proceeding. Then click "Ethernet to set DHCP/Static mode. (Both modes are available)



- By default, the IP setting is DHCP mode, which assigns dynamic IP address to the device (recommended).
- Static mode requires manual configuration of the IP address. Please make sure the IP address is not in conflict with other devices, you can visit the router to check the IP addresses of other devices.

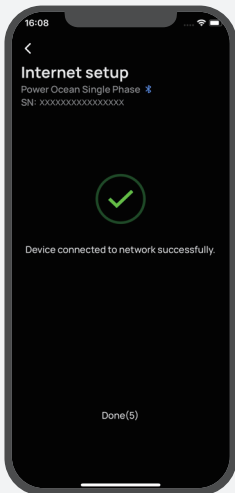
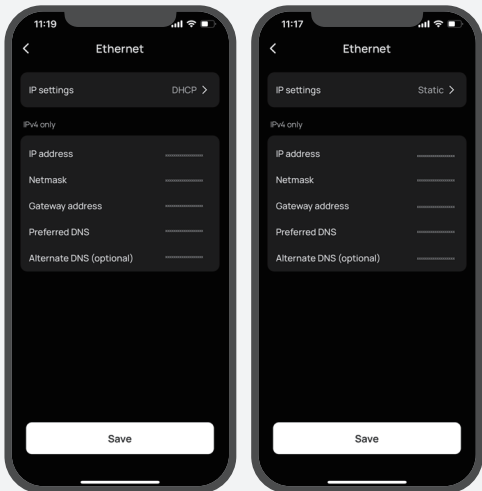
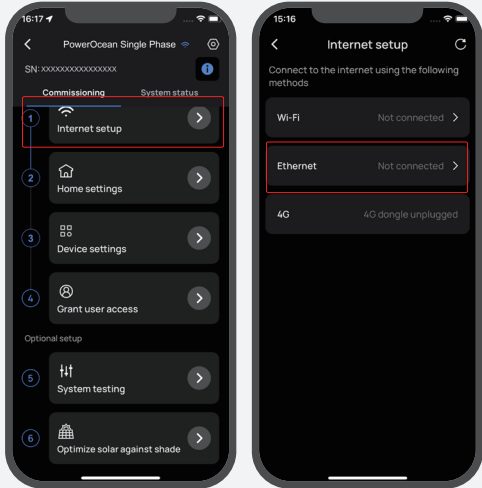

Method 3: 4G

1. Install a nano SIM card to the EcoFlow 4G Dongle ESS(EU).
2. Install the dongle onto the USB port (4G) of the inverter.
3. Activate your SIM card through App.



For more details about EcoFlow 4G Dongle ESS(EU), please refer to its user manual.

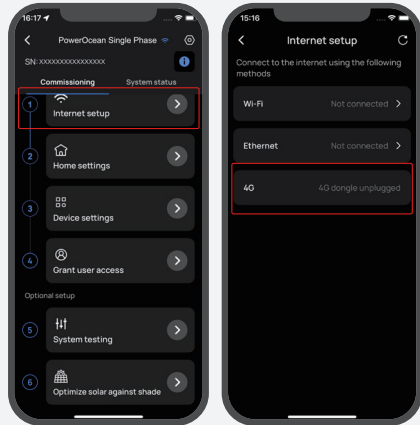

Step2: Home Setting

Click **Home Setting** to enter the corresponding house address.

(Optional) Set the electricity rate.

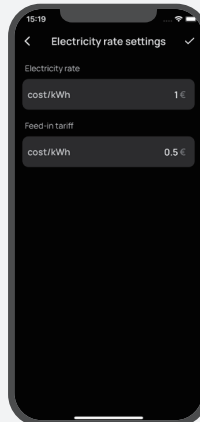
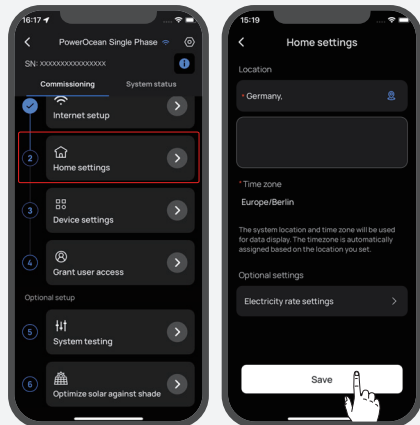

Step3: Device Setting

a. Click **Device Setting** to verify that the devices in the device list match the connected devices.

(Optional) Update firmware before carrying out Device Setting.

If there is a firmware update available for the EcoFlow PowerOcean system, the update page will pop up to notify you when proceeding this step. The "Skip" button is available for some update that is not urgent. It is highly recommended that you upgrade your PowerOcean firmware for seamless experience immediately.

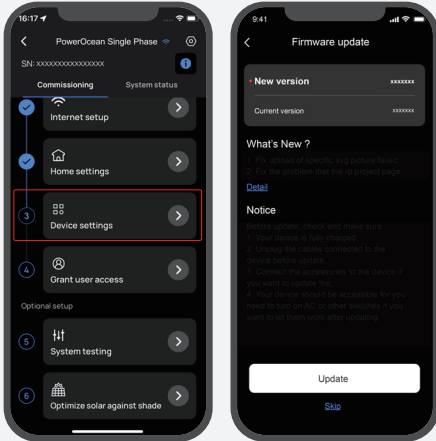

b. Set grid code, system work mode and feed-in power limitation.

c. (Optional) You can also tap **Customize Settings** to set Connection parameters, Voltage Protection parameters, Frequency Protection parameters, Reactive Power parameters and other parameters. (Please follow local regulations, if you need to change any of these parameters, please contact your local power organization first.)

d. Click **Done** to finish the commissioning.

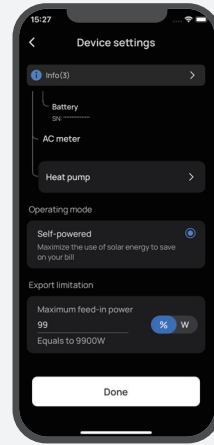
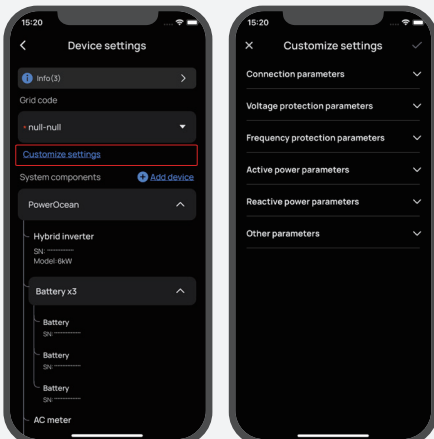

6

GRANT USER ACCESS

Click **Grant User Access** for a home owner access QR code to allow users to scan it.



- After manually adding device **EcoFlow PowerOcean** using the EcoFlow User App, users scan the home owner access QR code to bind it.

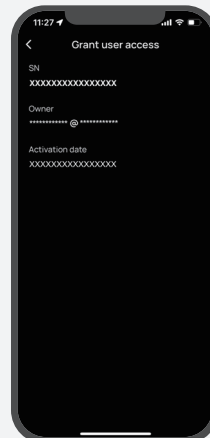
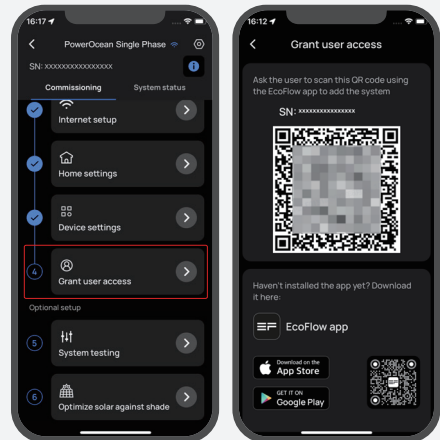

7

(OPTIONAL) SYSTEM TESTING

To test the go off-grid feature, you can toggle the button to switch the connection status of the system.

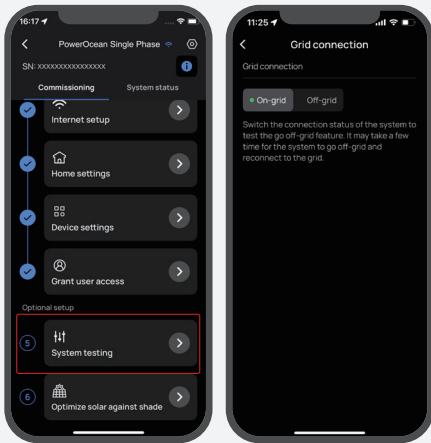

8

(OPTIONAL) OPTIMIZE SOLAR AGAINST SHADE

If this feature is enabled, the system will optimize solar generation in shaded conditions at your setup intervals to track the maximum power point. Solar generation may fluctuate.

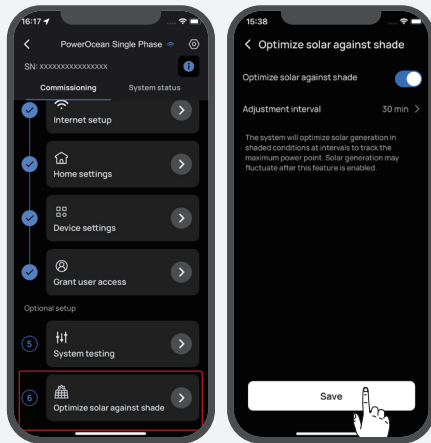

(OPTIONAL) ADD DEVICE TO POWEROCEAN SYSTEM

After correctly wiring power cables and communication cables with PowerOcean system, tap "Device setting"->"Add Device" to add devices to EcoFlow Pro App, such as third-party PV inverter, PowerHeat, etc., and then make some relevant settings.

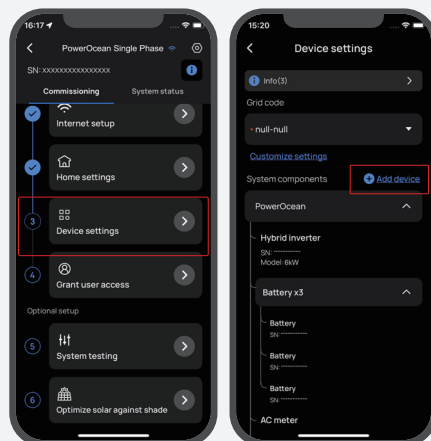

How Users Add Devices

1. DOWN AND INSTALL ECOFLOW USER APP (FOR USER ONLY)

Scan the QR code or download at: <https://download.ecoflow.com/app>

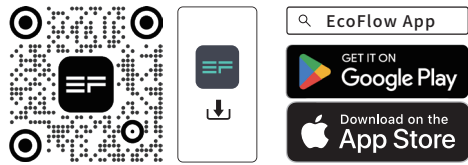

2. CREATE NEW ACCOUNT AND LOG IN.

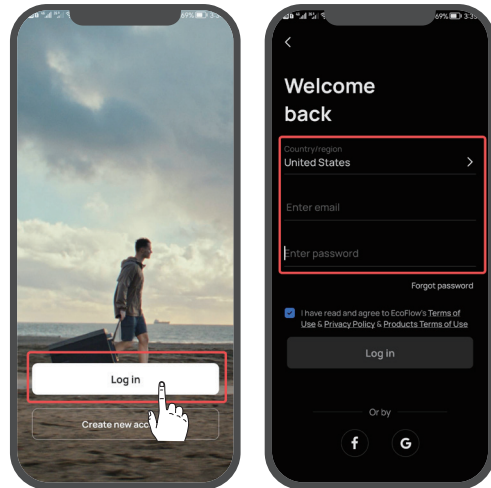

3. ADD DEVICE MANUALLY.

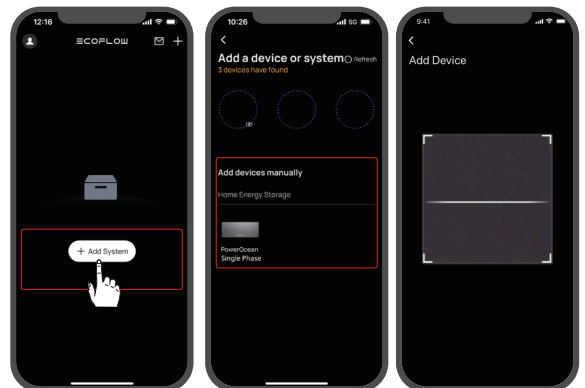

(Optional) Inverter Cascading

1 FOLLOW THE INSTRUCTIONS IN THE SECTION "SYSTEM COMMISSIONING" ABOVE TO CARRY OUT COMMISSIONING FOR EACH INVERTER TO BE CASCADED.

2 FIRMWARE UPDATE

If the current firmware of inverters to be cascaded don't support cascading, you need to add them to the EcoFlow App /Pro App and update their firmwares before proceeding.

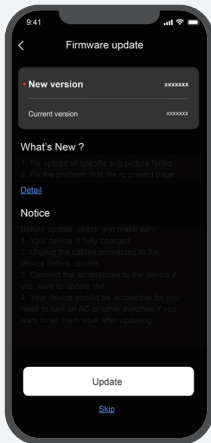
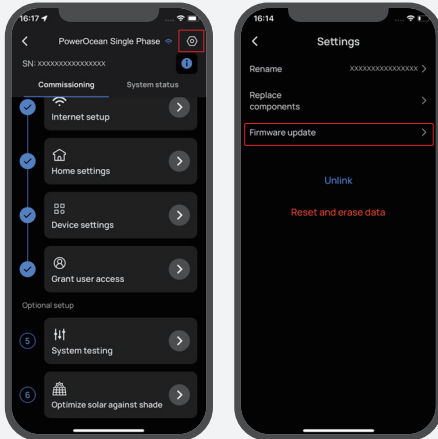

3 SYSTEM STOP

- Prefer to press the Emergency Stop button (if there is any) to stop the inverters which are running.
- If no Emergency Stop button is configured, you need to access to the EcoFlow App and select "Device setting"->"Stop running" to stop the systems.

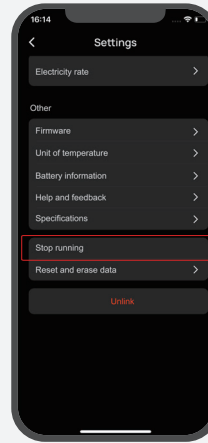
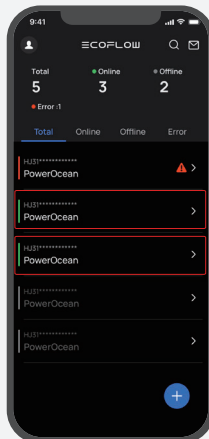

4 CONNECT INVERTER CASCADING CABLE CORRECTLY. SEE THE SECTION "(OPTIONAL) CONNECTING COMMUNICATION CABLES BETWEEN THE CASCADED EF HD-P1-(3K-6K)-S1".

5 INVERTER CASCADING SETUP

Tap the inverter with meter connected on the device list page, then select "Device setting"->"Add device" -> "Inverter cascading setup" to set the inverter with meter connected as the primary inverter, the others will be the secondary inverters by default. Follow the in-App instructions to complete the cascading setup.

The inverter to which the meter is connected must be set as the primary inverter.

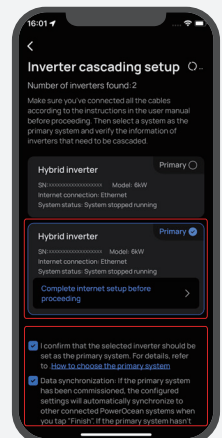
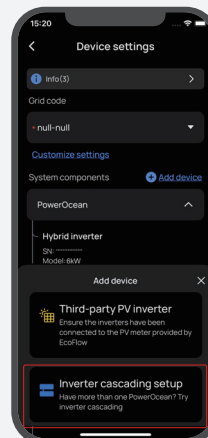
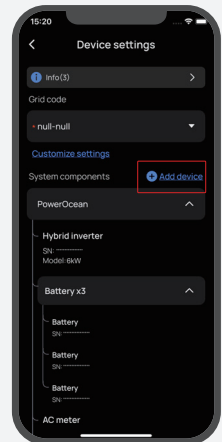
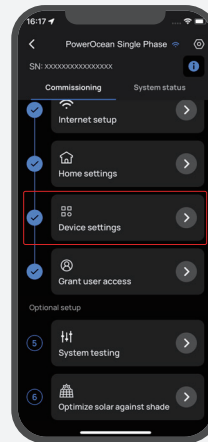

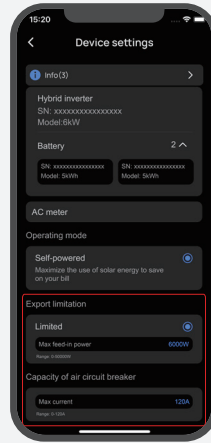
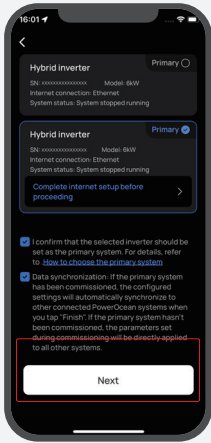

6 START SYSTEM

- Prefer to twist release the Emergency Stop button (if there is any) to start the systems.
- If no Emergency Stop button is configured, you need to access to the EcoFlow App and select "Device setting"->"Start system" to start the systems.

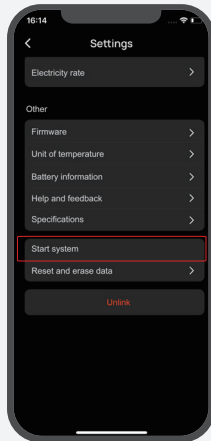
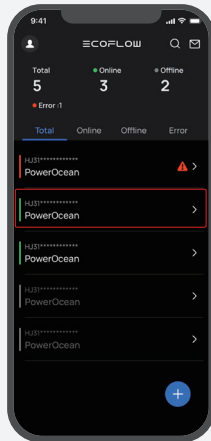

7 SET CAPACITY OF AIR CIRCUIT BREAKER AND EXPORT LIMITATION FOR THE CASCADING SYSTEM

Access to the EcoFlow Pro App, then select "Device setting" to set the capacity of air circuit breaker (0-120A) based on user's home actual current of air circuit breaker, and set export limitation (0-50kW) for the cascading system.

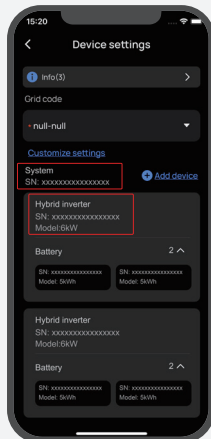
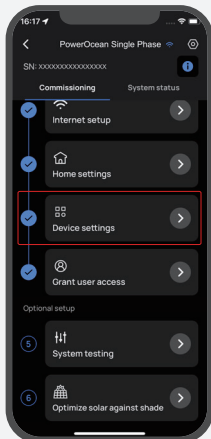

- For more details about device settings, please scan the QR code or visit:

Q <https://enterprise.ecoflow.com/eu/documentation>



